

INSTALLATION, OPERATING & MAINTENANCE MANUAL

Ultima Compact Condensing Unit Air Cooled Condensing Unit 30kW - 450kW



About Airedale Products & Customer Services

WARRANTY, COMMISSIONING & MAINTENANCE

As standard, Airedale guarantees all non consumable **parts only** for a period of **12 months**, variations tailored to suit product and application are also available, please contact Airedale for full terms and details.

To further protect your investment in Airedale products, we have introduced Airedale Service, who can provide full commissioning services, comprehensive maintenance packages and service cover 24 hours a day, 365 days a year (UK mainland). For a free quotation contact our Airedale Service or your local Sales Engineer.

All Airedale products are designed in accordance with EU Directives regarding prevention of build up of water, associated with the risk of contaminants such as Legionella.

Where applicable, effective removal of condensate is achieved by gradient drainage to outlets and where used, humidification systems produce sterile, non-toxic steam during normal operation.

For effective prevention of such risk it is necessary that the equipment is maintained in accordance with Airedale recommendations.

CAUTION

Warranty cover is not a substitute for Maintenance. Warranty cover is conditional to maintenance being carried out in accordance with the recommendations provided during the warranty period. Failure to have the maintenance procedures carried out will invalidate the warranty and any liabilities by Airedale International Air Conditioning Ltd.

SPARES

A spares list for 1, 3 and 5 years will be supplied with every unit and is also available from our Spares department on request.

TRAINING

As well as our comprehensive range of products, Airedale offers a modular range of Refrigeration and Air Conditioning Training courses, for further information please contact Airedale.

CUSTOMER SERVICES

For further assistance, please e-mail: enquiries@airedale.com or telephone:

UK Sales Enquiries	+ 44 (0) 113 238 7789	enquiries@airedale.com
International Enquiries	+ 44 (0) 113 239 1000	enquiries@airedale.com
Spares Hot Line	+ 44 (0) 113 238 7878	spares@airedale.com
Airedale Service	+ 44 (0) 113 239 1000	service@airedale.com
Technical Support	+ 44 (0) 113 239 1000	tech.support@airedale.com
Training Enquiries	+ 44 (0) 113 239 1000	marketing@airedale.com

For information, visit us at our Web Site: www.airedale.com

AIAC Ltd endeavours to ensure that the information in this document is correct and fairly stated, but none of the statements are to be relied upon as a statement or representation of fact. AIAC Ltd does not accept liability for any error or omission, or for any reliance placed on the information contained in this document.

The development of Airedale products and services is continuous and the information in this document may not be up to date. It is important to check the current position with AIAC Ltd at the address stated. This document is not part of a contract or licence unless expressly agreed.

No part of this document may be reproduced or transmitted in any form or by any means, electronic or mechanical, including photocopying, recording, or information storage and retrieval systems, for any purpose other than the purchaser's personal use, without the express written permission of AIAC Ltd.

© 2014 Airedale International Air Conditioning Limited. All rights reserved. Printed in the UK.

Contents

GENERAL STATEMENT	4
WARRANTY	5
GENERAL DESCRIPTION	6
Unit Identification	6
Introduction	6
Standard Features	6
Features - Variations	8
Optional Extras - Energy Saving	9
Optional Extras – General	9
INSTALLATION DATA	10
Dimensions	10
Unit Lifting	14
Anti Vibration Mounting – Optional	15
Positioning	16
Refrigeration System	17
Refrigeration Connections	18
Pipe Sizing Guide	18
Pipework Installation	18
Pressure Testing	19
Evacuation	19
Electrical	19
Interconnecting Wiring	20
Electrical Data	21
CONTROLS	25
Viewing Unit Operating Status	26
Setting up	26
Alarms	27
COMMISSIONING DATA	28
Operating Limits	28
Mechanical Data	28
Unloading Protection	28
COMMISSIONING PROCEDURE	30
Pre Commissioning Checklist	30
Commissioning Checklist	32
MAINTENANCE	35
General Maintenance	35
Compressor Maintenance	36
Shut Down Periods	36
PARTS IDENTIFICATION	37

General Statement

IMPORTANT

The information contained in this manual is critical to the correct operation and maintenance of the unit and should be read by all persons responsible for the installation, commissioning and maintenance of this Airedale unit.

SAFETY

The equipment has been designed and manufactured to meet international safety standards but, like any mechanical/electrical equipment, care must be taken if you are to obtain the best results.

- CAUTION** ▼ 1 **Service and maintenance of Airedale equipment should only be carried out by Technically trained competent personnel.**
- CAUTION** ▼ 2 **When working with any air conditioning units ensure that the electrical isolator is switched off prior to servicing or repair work and that there is no power to any part of the equipment.**
- 3 Also ensure that there are no other power feeds to the unit such as fire alarm circuits, BMS circuits etc
- 4 Electrical installation commissioning and maintenance work on this equipment should be undertaken by competent and trained personnel in accordance with local relevant standards and codes of practice.
- 5 Refrigerant used in this range of products is classified under the COSHH regulations as an irritant, with set Occupational Exposure Levels (OEL) for consideration if this plant is installed in confined or poorly ventilated areas.
- 6 A full hazard data sheet in accordance with COSHH regulations is available should this be required.

Warranty

GENERAL

To be read in conjunction with Airedale International Air Conditioning Ltd standard Conditions of Sale.

The equipment carries Airedale's standard warranty for a period of 24 months from the date of despatch or of invoice whichever ever is the sooner in respect of non-consumable parts only and does not include for the cost of labour incurred during the investigation or replacement of a defective item.

WARRANTY IS ONLY VALID IN THE EVENT THAT:

- 1 The equipment is serviced & maintained by Airedale or an approved Airedale company in accordance with the Installation & Maintenance manual provided, during the Warranty Period.
- 2 Commissioning is carried out by Airedale or an approved Airedale company.
- 3 **Commissioning documents have been completed and returned to Airedale within 28 days of the date of commissioning.**
- 4 Replaced faulty parts have been returned to Airedale within 21 days of replacement for evaluation.

Any spare part supplied by Airedale under the warranty shall be warranted for the unexpired period of the warranty or 3 months from delivery whichever period is the longer, with the exception of compressors on which a further 12 months warranty is granted.

PROCEDURE

When a component part fails, a replacement part should be obtained through our Spares department. If the part is considered to be under warranty, the following details are required to process this requirement.

- Full description of part required, including Airedale's part number, if known.
- The original equipment serial (U) or (BP) number.
- An appropriate purchase order number.

Faulty Component Return Tag		No	28401
CUSTOMER	_____	DATE	_____
ADDRESS	_____		
AIREDALE U/No	_____	CUST. O/No	_____
TYPE OF UNIT	_____		
COMPONENT DESCRIPTION	_____		
SERIAL No (where applicable)	_____		
FAULTY DESCRIPTION ('Faulty' or 'Defective' not sufficient)	_____		
DATE OF INVOICE	1. Original Equipment _____		
DATE OF INSTALLATION	2. Component (if different) _____		
DATE OF FAILURE	_____		
Airedale International Air Conditioning Limited Leeds Road, Rawdon, Leeds LS19 6JY Tel: 0113 228 1000 Fax: 0113 250 7219 700-006			CUSTOMER COPY

A spares order will be raised under our "G" number system and the replacement part will be despatched, usually within 24 hours should they be in stock.

When replaced, the faulty part must be returned to Airedale with a suitably completed and securely attached "Faulty Component Return" (FCR) tag. FCR tags are available from Airedale and supplied with each "G" order.

On receipt of the faulty part, suitably tagged, Airedale will pass to its Warranty department, where it will be fully inspected and tested in order to identify the reason for failure, identifying at the same time whether warranty is justified or not.

On completion of the investigation of the returned part, a full "Report on Goods Returned" will be issued. On occasion the release of this complete report may be delayed as component manufacturer becomes involved in the investigation.

When warranty is allowed, a credit against the "G" number invoice will be raised. Should warranty be refused the "G" number invoice becomes payable on normal terms.

EXCLUSIONS

Warranty may be refused for the following reasons:

- Misapplication of product or component
- Incorrect site installation
- Incomplete commissioning documentation
- Inadequate site installation
- Inadequate site maintenance
- Damage caused by mishandling
- Replaced part being returned damaged without explanation
- Unnecessary delays incurred in return of defective component

RETURNS ANALYSIS

All faulty components returned under warranty are analysed on a monthly basis as a means of verifying component and product reliability as well as supplier performance. It is important that all component failures are reported correctly.

General Description

UNIT IDENTIFICATION

AIR COOLED CONDENSING UNIT	
UCCU	Ultima Compact Condensing Unit - Cooling Only
30 - 450	Model Size (Expressed as Nominal Cooling in kW)
SQ-	Single Circuit - Quiet (Models 30-80 (Except 75) Only)
SSQ-	Single Circuit - Super Quiet (Models 30-80 (Except 75) Only)
D-	Double Circuit - Standard
DQ-	Double Circuit - Quiet
DSQ-	Double Circuit - Super Quiet
2-16	Number of Fans
/1 or /2	Single or Double Row of Fans
Example	UCCU250DQ-8/2

INTRODUCTION

The Airedale range of Ultima Compact air cooled condensing units covers the nominal capacity range 30kW to 450kW in 24 model sizes. The range is available with many optional variations including **Quiet** and **Super Quiet** sound level variants.

The range is suitable for a wide range of split-system applications such as Cold Storage, large Retail Comfort Cooling, Process Cooling, Healthcare, Hi-Tech environments and leisure.

Attention has been placed on maximising the unit's performance while keeping the sound and vibration levels and footprint to an absolute minimum.

CE DIRECTIVE



Airedale certify that the equipment detailed in this manual conforms with the following EC Directives:

Electromagnetic Compatibility Directive (EMC)	89/336/EEC
Low Voltage Directive (LVD)	73/23/EEC
Machinery Directive (MD)	89/392/EEC in the version 98/37/EC
Pressure Equipment Directive (PED)	97/23/EC

To comply with these directives appropriate national & harmonised standards have been applied. These are listed on the Declaration of Conformity, supplied with each product.

Maximum and Minimum Operation Temperature (TS) and Pressure (PS)	
Operating Temperature (TS),	TS = Min -20°C to Max 120°C *
Maximum Operating Pressure (PS)	PS = High Side 26 Barg

*Based upon the maximum machine running temperatures.

REFRIGERANTS

The range has been designed and optimised for operation with the ozone benign R407C refrigerant.

STANDARD FEATURES

All models sizes.

Construction

The base is fabricated from galvanised steel to ensure a tough, durable, weatherproof construction.

The superstructure is manufactured from galvanised sheet steel coated with epoxy baked powder paint to provide a durable and weatherproof finish. Standard unit colour is Light Grey (RAL 7035).

Compressors and heat exchangers are mounted on a rigid galvanised heavy-duty sub frame. Fully weatherproofed electrical panels are situated at one end of the unit. Access to the compressors is via end panels adjacent to the electrical control panel.

Other features include:

- Dedicated Compressor Enclosure
- Condenser Fan Discharge Plenum

General Description

STANDARD FEATURES All models sizes.

Condenser	Large surface area coil(s) ideally positioned to optimise airflow and heat transfer, manufactured from refrigeration quality copper tubes with mechanically bonded aluminium fins.
Condenser Fan	Axial fan assemblies with fingerproof grille and incorporating external rotor motor technology, to provide highly accurate discreet speed control, discharge air vertically. The fans offer maximum performance while keeping sound levels to a minimum. Electrical supply dependent upon model size, refer to Electrical Data .
Head Pressure Control	Electronic head pressure controllers are fitted which modulate the fan speed to maintain a constant condensing pressure, allowing the system to operate satisfactorily in ambient temperatures as low as -20°C. Head pressure can be set, monitored and values viewed at the microprocessor keypad.
Compressor	Scroll compressors comprising: <ul style="list-style-type: none">• Internal motor protection• Internal pressure relief• Non return valve• External discharge temperature protection• Oil sight glass• Sump heater Each Tandem / Trio set has an oil equalisation line. The compressors are mounted to the rigid galvanised heavy duty sub-frame with the use of vibration reducing isolation.
Refrigeration	Each refrigeration circuit is supplied with the following: <ul style="list-style-type: none">• Holding charge of Helium• Liquid line ball valve• Suction line ball valve• Low pressure cut out with manual reset via microprocessor controller• High pressure switch with manual reset• Pressure relief valve with integral rupture disc and indicator gauge Refer to Features - Variations for further detail.
Controls	AIRETronix microprocessor controller can provide 2-6 stages of capacity control, dependent upon model type, as standard. The controller incorporates full Building Management System capabilities, full details can be found in the Controls section. Control management is offered in 1 of 4 of the most common types, to select via the microprocessor, to be specified at time of order: <ul style="list-style-type: none">• External 0-10V Signal• Suction Pressure Monitoring• Remote Space Temperature Sensor• Remote Digital Inputs
Electrical	Dedicated weatherproof electrical power and controls panels are situated at the end of the unit and contain: <ul style="list-style-type: none">• Separate, fully accessible, controls compartment, allowing adjustment of control set points whilst the unit is operational• Circuit breakers for protection of all major unit components• Separate, permanent supply for controls/trace heating, 230V/50Hz/1ph The electrical power and control panel is wired to the latest European standards and codes of practice. Refer to Features - Variations for further detail.

FEATURES - VARIATIONS	UCCU30, UCCU40, UCCU50, UCCU60, UCCU70 & UCCU80	UCCU75, UCCU100, UCCU125 & UCCU150	UCCU110, UCCU130, UCCU160 & UCCU180	UCCU200, UCCU225 & UCCU250	UCCU240, UCCU270, UCCU300, UCCU330, UCCU360, UCCU400 & UCC450
Construction					
4 x eye bolts to BS4278 or Integrated lugs/Mounting feet	Integrated lugs	Lifting Eye Bolts	Lifting Eye Bolts	Lifting Eye Bolts	Lifting Eye Bolts
Acoustically lined compressor enclosure	SSQ/DSQ Models	DSQ Models	DSQ Models	DSQ Models	DSQ Models
Refrigeration					
Holding charge of Helium	Std	Std	Std	Std	Std
Number of Independent Refrigeration Circuits	1 or 2	2	2	2	2
Scroll Compressor Arrangement	1 x Tandem Set or 2 x Single	2 x Tandem Sets	2 x Tandem Sets	2 x Tandem Sets	2 x Trio Sets
Sickle Bladed Fans	Std	Std - c/w Long Bellmouth	Std - c/w Long Bellmouth	Std - c/w Long Bellmouth	Std - c/w Long Bellmouth
Low speed condenser fan	SQ/DQ Models	DQ Models	DQ Models	DQ Models	DQ Models
Extra Low speed condenser fan	SSQ/DSQ Models	DSQ Models	DSQ Models	DSQ Models	DSQ Models
Electrical					
Emergency stop	-	Std	Std	Std	Std
Door isolated mains power compartments	-	-	Std	Std	Std
Dedicated bus-bar chamber for incoming 3-phase & earth mains power supply (no neutral required)	-	-	Std	Std	Std
Mains Supply 3 Phase	Std	Std	Std	Std	Std
Neutral Required	Yes	No	No	No	No
Phase Rotation Protection	Opt	Opt	Opt	Std	Std
Power Factor Correction	-	Opt	Opt	Opt	Opt

General Description

OPTIONAL EXTRAS - ENERGY SAVING

Power Factor Correction When applied to the motors of each compressor, the compressor power factor is controlled to a minimum operating value of 0.95 at the full operating capacity. This satisfies many supply authorities that may impose surcharges on equipment with power factor less than 0.95.

OPTIONAL EXTRAS – GENERAL

Loose Item

- Anti Vibration Mounts
- Condenser Fan Discharge Air Plenum Extension
- Power Factor Correction

Factory Fitted

- Epoxy Coated Condenser Coils
- Coil Guards
- Dual Pressure Relief Valve
- Discharge Line Ball Valve
- Discharge Line non-Return Valve
- Suction Line Accumulator
- Liquid Receiver & Pressure Relief Valve
- Filter Drier & Sight Glass
- Leak Detection Kit
- Electronic Soft Start
- Phase Rotation Protection
- BMS Interface Card
- Remote Setpoint Adjust
- Alternative Refrigerant (Outside EU)

Installation Data

DIMENSIONS

SINGLE ROW FANS - /1

UCCU30 - UCCU80
(Except UCCU75)

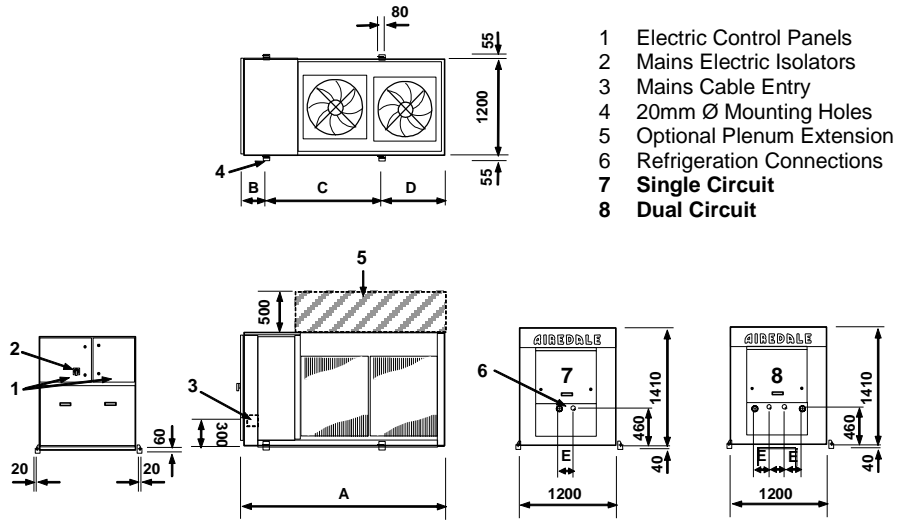

- 1 Electric Control Panels
- 2 Mains Electric Isolators
- 3 Mains Cable Entry
- 4 20mm Ø Mounting Holes
- 5 Optional Plenum Extension
- 6 Refrigeration Connections
- 7 **Single Circuit**
- 8 **Dual Circuit**

Model SQ/DQ		A	B	C	D	E
UCCU30 - UCCU40 SQ/DQ	mm	1650	300	1050	300	200
UCCU50 - UCCU70 SQ/DQ	mm	2500	300	1450	750	200
UCCU80 SQ/DQ	mm	2500	300	1450	750	200

Model SSQ/DSQ		A	B	C	D	E
UCCU30 - UCCU40 SSQ/DSQ	mm	1650	300	1050	300	200
UCCU50 - UCCU70 SSQ/DSQ	mm	2500	300	1450	750	200
UCCU80 SSQ/DSQ	mm	2500	300	1450	750	200

UCCU75 - UCCU150
(Except UCCU80)

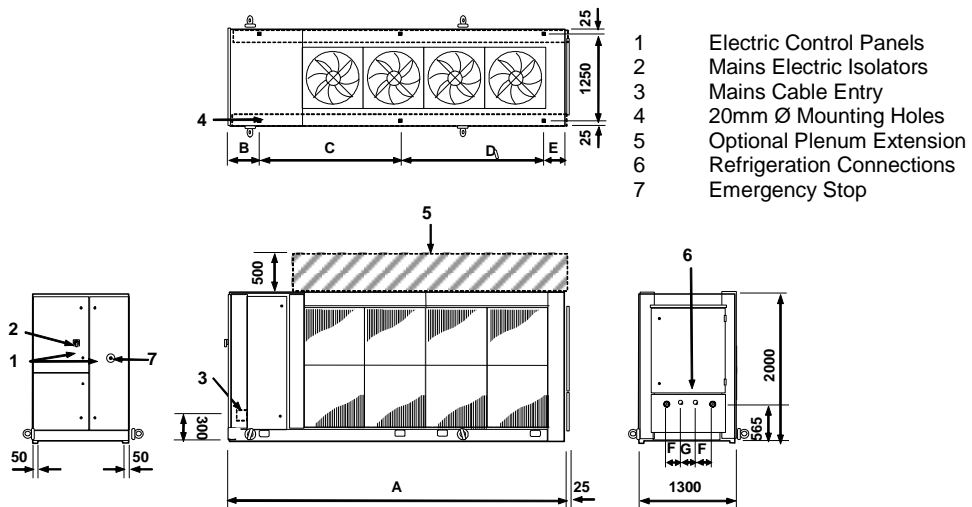

- 1 Electric Control Panels
- 2 Mains Electric Isolators
- 3 Mains Cable Entry
- 4 20mm Ø Mounting Holes
- 5 Optional Plenum Extension
- 6 Refrigeration Connections
- 7 Emergency Stop

Model D		A	B	C	D	E	F	G
UCCU75D-2/1	mm	2775	390	1900	(1)	485	200	170
UCCU100D-2/1	mm	2775	390	1900	(1)	485	200	170
UCCU125D-3/1	mm	3625	390	1825	1135	275	200	170
UCCU150D-3/1	mm	3625	390	1825	1135	275	200	170

Model DQ		A	B	C	D	E	F	G
UCCU75DQ-2/1	mm	2775	390	1900	(1)	485	200	170
UCCU100DQ-2/1	mm	2775	390	1900	(1)	485	200	170
UCCU125DQ-3/1	mm	3625	390	1825	1135	275	200	170
UCCU150DQ-4/1	mm	4475	390	1900	1900	285	200	170

Model DSQ		A	B	C	D	E	F	G
UCCU75DSQ-3/1	mm	3625	390	1825	1135	275	200	170
UCCU100DSQ-3/1	mm	3625	390	1825	1135	275	200	170
UCCU125DSQ-4/1	mm	4475	390	1900	1900	285	200	170
UCCU150DSQ-4/1	mm	4475	390	1900	1900	285	200	170

(1) Have only 4 fixing and 4 point loadings.

Installation Data

POINT LOADINGS, WEIGHTS & CENTRE OF GRAVITY (C OF G) SINGLE ROW FANS - /1

UCCU30 - UCCU80 (Except UCCU75)

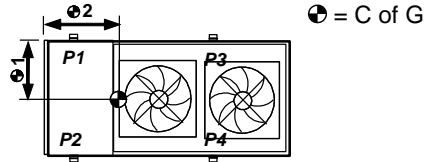

Model SQ/DQ		P1	P2	P3	P4	(1)	(1)	Operating Weight	C of G1 (mm)	C of G2 (mm)
UCCU30 SQ/DQ-1/1	kg	120	120	115	115			470	600	815
UCCU40 SQ/DQ-1/1	kg	140	140	135	135			550	600	815
UCCU50 SQ/DQ-2/1	kg	170	170	175	175			690	600	1035
UCCU60 SQ/DQ-2/1	kg	180	180	190	190			740	600	1045
UCCU70 SQ/DQ-2/1	kg	185	185	195	195			760	600	1045
UCCU80 SQ/DQ-2/1	kg	200	200	215	215			830	600	1050

Model SSQ/DSQ		P1	P2	P3	P4	(1)	(1)	Operating Weight	C of G1 (mm)	C of G2 (mm)
UCCU30 SSQ/DSQ-1/1	kg	120	120	120	120			480	600	825
UCCU40 SSQ/DSQ-1/1	kg	145	145	140	140			570	600	815
UCCU50 SSQ/DSQ-2/1	kg	175	175	175	175			700	600	1025
UCCU60 SSQ/DSQ-2/1	kg	185	185	190	190			750	600	1035
UCCU70 SSQ/DSQ-2/1	kg	185	185	200	200			770	600	1055
UCCU80 SSQ/DSQ-2/1	kg	210	210	225	225			870	600	1050

UCC75 - UCC150 (Except UCC80)

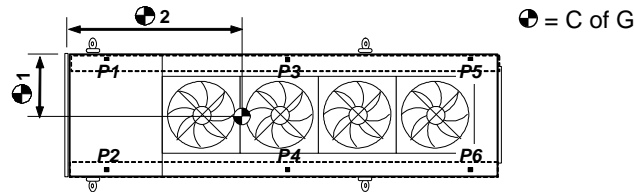

Model D		P1	P2	P3	P4	P5	P6	Operating Weight	C of G1 (mm)	C of G2 (mm)
UCCU75D-2/1	kg	305	305	(1)	(1)	165	165	940	650	1055
UCCU100D-2/1	kg	320	320	(1)	(1)	165	165	970	650	1035
UCCU125D-3/1	kg	300	280	185	175	135	135	1210	635	1595
UCCU150D-3/1	kg	305	305	190	190	130	130	1250	650	1560

Model DQ		P1	P2	P3	P4	P5	P6	Operating Weight	C of G1 (mm)	C of G2 (mm)
UCCU75DQ-2/1	kg	305	305	(1)	(1)	165	165	940	650	1055
UCCU100DQ-2/1	kg	325	325	(1)	(1)	180	180	1010	650	1065
UCCU125DQ-3/1	kg	305	285	185	175	135	125	1210	630	1570
UCCU150DQ-4/1	kg	325	325	240	240	190	190	1510	650	1950

Model DSQ		P1	P2	P3	P4	P5	P6	Operating Weight	C of G1 (mm)	C of G2 (mm)
UCCU75DSQ-3/1	kg	285	285	165	165	125	125	1150	650	1555
UCCU100DSQ-3/1	kg	290	290	165	165	135	135	1180	650	1580
UCCU125DSQ-4/1	kg	315	295	250	240	195	185	1480	635	1995
UCCU150DSQ-4/1	kg	330	330	270	270	210	210	1620	650	2010

(1) Have only 4 fixing and 4 point loadings.

Installation Data

DIMENSIONS

DOUBLE ROW FANS - /2

UCCU110 - UCCU450

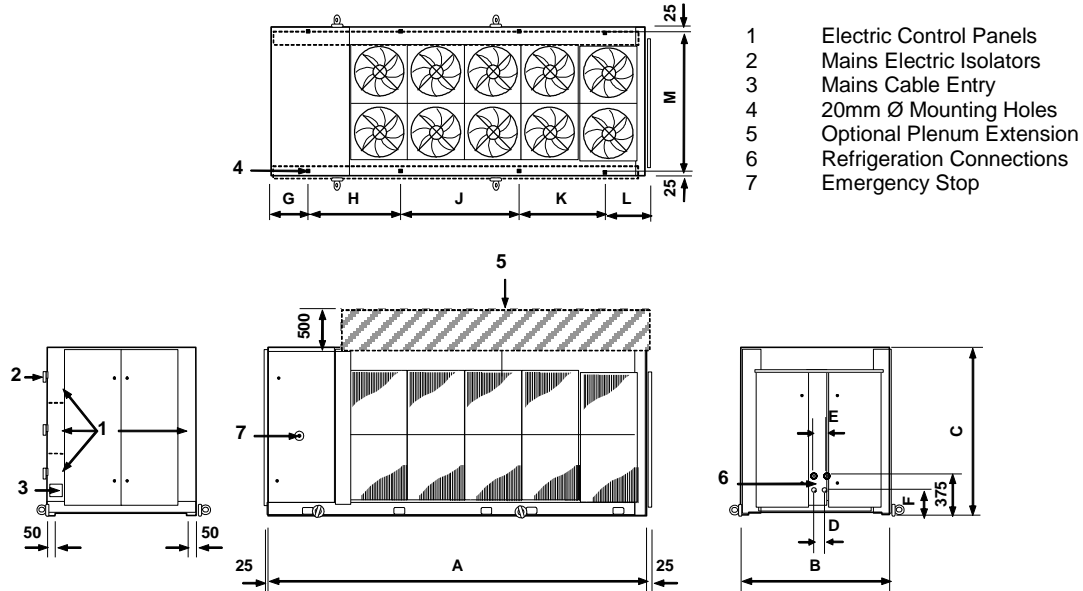

Model D		A	B	C	D	E	F	G	H	J	K	L	M
UCCU110D - UCCU160D	mm	2365	1850	2100	115	140	205	275	1600	(1)	(1)	490	1800
UCCU180D - UCCU225D	mm	3170	1850	2100	115	140	205	480	1100	1100	(2)	490	1800
UCCU240D	mm	4650	2200	2180	140	150	225	350	1750	1925	(2)	625	2150
UCCU250D	mm	3170	1850	2100	115	140	205	480	1100	1100	(2)	490	1800
UCCU270D - UCCU300D	mm	4650	2200	2180	140	150	225	350	1750	1925	(2)	625	2150
UCCU330D - UCCU360D	mm	5500	2200	2180	140	150	225	350	1350	1350	1925	525	2150
UCCU400D - UCCU450D	mm	6350	2200	2180	140	150	225	350	1700	1925	1925	450	2150

Model DQ		A	B	C	D	E	F	G	H	J	K	L	M
UCCU110DQ - UCCU130DQ	mm	2365	1850	2100	115	140	205	275	1600	(1)	(1)	490	1800
UCCU160DQ - UCCU200DQ	mm	3170	1850	2100	115	140	205	480	1100	1100	(1)	490	1800
UCCU225DQ	mm	3975	1850	2100	115	140	205	480	1500	1500	(2)	495	1800
UCCU240DQ	mm	4650	2200	2180	140	150	225	350	1750	1925	(2)	625	2150
UCCU250DQ	mm	3975	1850	2100	115	140	205	480	1500	1500	(2)	495	1800
UCCU270DQ - UCCU300DQ	mm	5500	2200	2180	140	150	225	350	1350	1350	1925	525	2150
UCCU330DQ - UCCU360DQ	mm	6350	2200	2180	140	150	225	350	1700	1925	1925	450	2150
UCCU400DQ - UCCU450DQ	mm	7200	2200	2180	140	150	225	350	1700	2700	2000	450	2150

Model DSQ		A	B	C	D	E	F	G	H	J	K	L	M
UCCU110DSQ	mm	2365	1850	2100	115	140	205	275	1600	(1)	(1)	490	1800
UCCU130DSQ - UCCU180DSQ	mm	3170	1850	2100	115	140	205	480	1100	1100	(2)	490	1800
UCCU200DSQ	mm	3975	1850	2100	115	140	205	480	1500	1500	(2)	495	1800
UCCU225DSQ	mm	3975	1850	2100	115	140	205	480	1500	1500	(2)	495	1800
UCCU240DSQ	mm	5500	2200	2180	140	150	225	350	1350	1350	1925	525	2150
UCCU250DSQ	mm	3975	1850	2100	115	140	205	480	1500	1500	(2)	495	1800
UCCU270DSQ - UCCU300DSQ	mm	6350	2200	2180	140	150	225	350	1700	1925	1925	450	2150
UCCU330DSQ - UCCU360DSQ	mm	7200	2200	2180	140	150	225	350	1700	2700	2000	450	2150
UCCU400DSQ - UCCU450DSQ	mm	8050	2200	2180	140	150	225	350	1700	2800	2725	525	2150

- (1) Have only 4 fixing and 4 point loadings.
 (2) Have only 6 fixing and 6 point loadings.

Installation Data

POINT LOADINGS, WEIGHTS & CENTRE OF GRAVITY (C OF G) DOUBLE ROW FANS - /2

UCCU110 - UCCU450

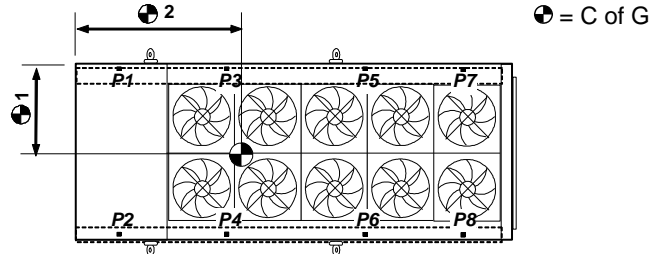

Model D		P1	P2	P3	P4	P5	P6	P7	P8	Operating Weight	C of G1 (mm)	C of G2 (mm)
UCCU110D-4/2	kg	380	380	(1)	(1)	(1)	(1)	280	280	1320	925	955
UCCU130D-4/2	kg	395	415	(1)	(1)	(1)	(1)	280	280	1370	940	930
UCCU160D-4/2	kg	470	470	(1)	(1)	(1)	(1)	235	235	1410	925	810
UCCU180D-6/2	kg	550	590	205	225	(2)	(2)	120	120	1810	955	1035
UCCU200D-6/2	kg	550	590	205	225	(2)	(2)	120	120	1810	955	1035
UCCU225D-6/2	kg	620	620	220	220	(2)	(2)	125	125	1930	925	1015
UCCU240D-8/2	kg	635	635	325	325	(2)	(2)	190	190	2300	1100	1450
UCCU250D-6/2	kg	620	620	220	220	(2)	(2)	125	125	1930	925	1015
UCCU270D-8/2	kg	680	680	330	330	(2)	(2)	195	195	2410	1100	1425
UCCU300D-8/2	kg	715	715	350	350	(2)	(2)	200	200	2530	1100	1415
UCCU330D-10/2	kg	690	690	340	340	190	190	190	190	2820	1100	1665
UCCU360D-10/2	kg	715	715	345	345	190	190	190	190	2880	1100	1640
UCCU400D-12/2	kg	740	740	380	380	255	255	245	245	3240	1100	2160
UCCU450D-12/2	kg	775	775	395	395	255	255	245	245	3340	1100	2120

Model DQ		P1	P2	P3	P4	P5	P6	P7	P8	Operating Weight	C of G1 (mm)	C of G2 (mm)
UCCU110DQ-4/2	kg	370	370	(1)	(1)	(1)	(1)	270	270	1280	925	950
UCCU130DQ-4/2	kg	385	405	(1)	(1)	(1)	(1)	265	265	1320	940	915
UCCU160DQ-6/2	kg	480	480	210	210	(2)	(2)	125	125	1630	925	1100
UCCU180DQ-6/2	kg	505	545	210	230	(2)	(2)	125	125	1740	955	1075
UCCU200DQ-6/2	kg	505	545	210	230	(2)	(2)	125	125	1740	955	1075
UCCU225DQ-8/2	kg	545	545	290	290	(2)	(2)	225	225	2120	925	1525
UCCU240DQ-8/2	kg	655	655	330	330	(2)	(2)	190	190	2350	1100	1435
UCCU250DQ-8/2	kg	545	545	290	290	(2)	(2)	225	225	2120	925	1525
UCCU270DQ-10/2	kg	650	650	325	325	195	195	180	180	2700	1100	1680
UCCU300DQ-10/2	kg	690	690	335	335	200	200	185	185	2820	1100	1660
UCCU330DQ-12/2	kg	715	715	375	375	245	245	230	230	3130	1100	2140
UCCU360DQ-12/2	kg	730	730	385	385	250	250	230	230	3190	1100	2130
UCCU400DQ-14/2	kg	760	760	415	415	300	300	290	290	3530	1100	2550
UCCU450DQ-14/2	kg	805	805	425	425	300	300	290	290	3640	1100	2490

Model DSQ		P1	P2	P3	P4	P5	P6	P7	P8	Operating Weight	C of G1 (mm)	C of G2 (mm)
UCCU110DSQ-4/2	kg	380	380	(1)	(1)	(1)	(1)	270	270	1300	925	940
UCCU130DSQ-6/2	kg	380	400	210	210	(2)	(2)	200	200	1600	935	1320
UCCU160DSQ-6/2	kg	405	405	220	220	(2)	(2)	200	200	1650	925	1305
UCCU180DSQ-6/2	kg	425	465	225	245	(2)	(2)	200	200	1760	955	1275
UCCU200DSQ-8/2	kg	480	520	265	285	(2)	(2)	240	240	2030	950	1300
UCCU225DSQ-8/2	kg	535	535	290	290	(2)	(2)	245	245	2140	925	1575
UCCU240DSQ-10/2	kg	635	635	315	315	190	190	180	180	2640	1100	1690
UCCU250DSQ-8/2	kg	535	535	290	290	(2)	(2)	245	245	2140	925	1575
UCCU270DSQ-10/2	kg	695	695	340	340	245	245	225	225	3010	1100	2155
UCCU300DSQ-12/2	kg	730	730	355	355	250	250	225	225	3120	1100	2120
UCCU330DSQ-14/2	kg	760	760	405	405	280	280	270	270	3430	1100	2475
UCCU360DSQ-14/2	kg	780	780	410	410	280	280	270	270	3480	1100	2450
UCCU400DSQ-16/2	kg	805	805	460	460	430	430	320	320	4030	1100	2830
UCCU450DSQ-16/2	kg	835	835	475	475	435	435	320	320	4130	1100	2790

- (1) Have only 4 fixing and 4 point loadings.
 (2) Have only 6 fixing and 6 point loadings.

Installation Data

UNIT LIFTING

- Employ lifting specialists.
- Local codes and regulations relating to the lifting of this type of equipment should be observed.
- Use the lifting eye bolts/lifting lugs provided.
- Attach lifting chains to the 4 lifting eye bolts/lifting lugs provided, each chain and eye bolt must be capable of lifting the whole chiller.
- Use the appropriate spreader bars/lifting slings with the holes/lugs provided.
- Lift the unit slowly and evenly.
- If the unit is dropped, it should immediately be checked for damage and reported to Airedale Service.

CAUTION Only use lifting points provided.

The unit should be lifted from the base and where possible, with all packing and protection in position. If any other type of slinging is used, due care should be taken to ensure that the slings do not crush the casework or coil.

LIFTING DIMENSIONS

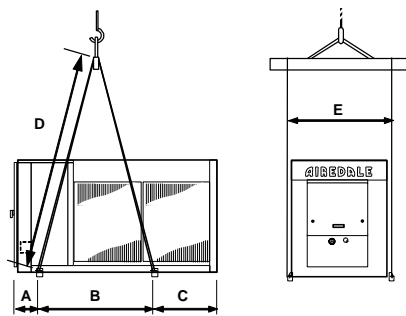

UCCU30 - 80 (Except UCCU75)		A	B ⁽¹⁾	C ⁽¹⁾	D ⁽¹⁾	E
1 FAN /1	mm	300	1050 (1450)	300 (300)	1900 (2200)	1270
2 FANS /1	mm	300	1450	750	2200	1270

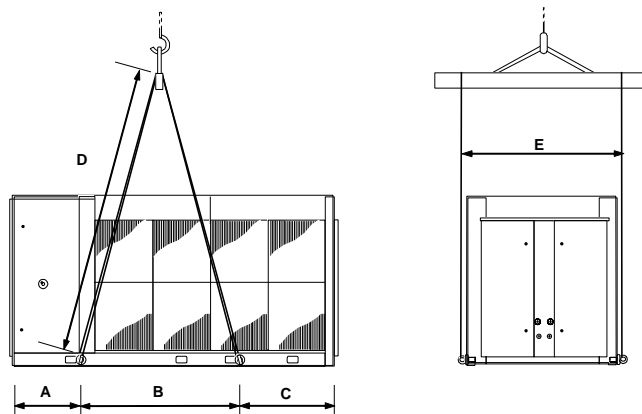

UCCU75 - UCCU250 (Except UCCU80)		A	B	C	D	E
2 FANS /1	mm	290	1900	585	2500	1450
3 FANS /1	mm	290	2015	1320	2500	1450
4 FANS /1	mm	290	2870	1315	3000	1450
4 FANS /2	mm	180	1580	605	2500	2000
6 FANS /2	mm	595	1650	925	2500	2000
8 FANS /2 (Tandem Compressor)	mm	595	2050	1330	2500	2350
8 FANS /2 (Trio Compressor)	mm	465	2560	1625	3000	2350
10 FANS/2	mm	465	3135	1900	3500	2350
12 FANS/2	mm	465	3610	2275	3500	2350
14 FANS/2	mm	465	4385	2350	4000	2350
16 FANS/2	mm	465	5035	2600	5000	2350

Installation Data

ANTI VIBRATION MOUNTING – OPTIONAL

COMPONENTS:

- 1 Locating Screw
- 2 Retaining Nut & Washer
- 3 Levelling Screw
- 4 Levelling Lock Nut
- 5 Retaining Studs
- 6a Upper Retaining Nuts
- 6b Lower Retaining Nuts
- 7 Spring assembly
- 8 Pressure Plate
- 9 Top Plate
- 10 Bolting-down holes

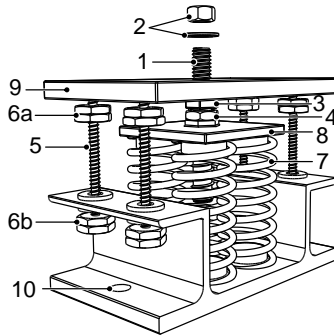

DIMENSIONS:

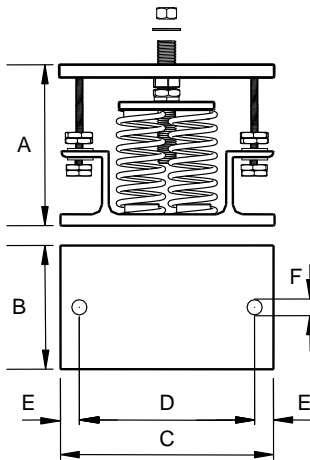

		A ⁽¹⁾	B	C	D	E	FØ
UCC30-70	2 SPRING	136	110	180	148	16	11
UCC75, 80, 100, 125 & 150							
UCCU30-70							
UCCU75, 80, 100, 125 & 150							
UCFC75-150							
UCC110, 130, 160-450	4 SPRING	180	130	225	186	20	16
UCCU110, 130, 160-450							
UCFC160-450							
UFC200-750							
URAC75-450							
USC200-750							
UWC75-450							

- (1) Unloaded dimension
- (2) Refer to relevant **Loose Parts Instructions** sheet for positioning of each mount.

INSTALLATION

- 1 Locate and secure mount using bolting down holes (10) in base plate.
- 2 Ensure mounts are located in line with the unit base.
- 3 If applicable, remove compressor enclosure covers to allow access to mount fixing holes in the unit base.
- 4 Lock the upper retaining nuts (6a) to the underside of the top plate (9) before a load is applied.
- 5 Remove retaining nut and washer (2), lower the unit onto the mounts and replace retaining nut and washer.
- 6 Beginning with the mount with the largest deflection, adjust the height of each mount using the levelling screw (3).

CAUTION **Mountings must be adjusted incrementally in turn. Do not fully adjust 1 mount at a time as this may overload and damage springs.**

- 7 When all mounts are level, lock each into place using the levelling lock nut (4).
- 8 Lock all retaining nuts (6a and 6b) to the extreme ends of the retaining studs (5).

CAUTION **Do not connect any services until all anti vibration mounts have been fully adjusted.**

Installation Data

POSITIONING

The installation position should be selected with the following points in mind:

- Position on a stable and even base, levelled to ensure that the compressor operates correctly.
- Levelling should be to +/- 5mm.
- Where vibration transmission to the building structure is possible, fit spring anti-vibration mounts and flexible water connections.
- Observe airflow and maintenance clearances.
- Pipework and electrical connections are readily accessible.
- Where multiple units are installed, due care should be taken to avoid the discharge air from each unit adversely affecting other units in the vicinity.
- Within a side enclosed installation, the fan MUST be higher than the enclosing structure.
- Figures in brackets indicate airflow and maintenance clearances for side-enclosed or multiple condensing unit applications.
- Ensure there are no obstructions directly above the fans.
- Allow free space above the fans to prevent air recirculation.

CAUTION  Prior to connecting services, ensure that the equipment is installed and completely level.

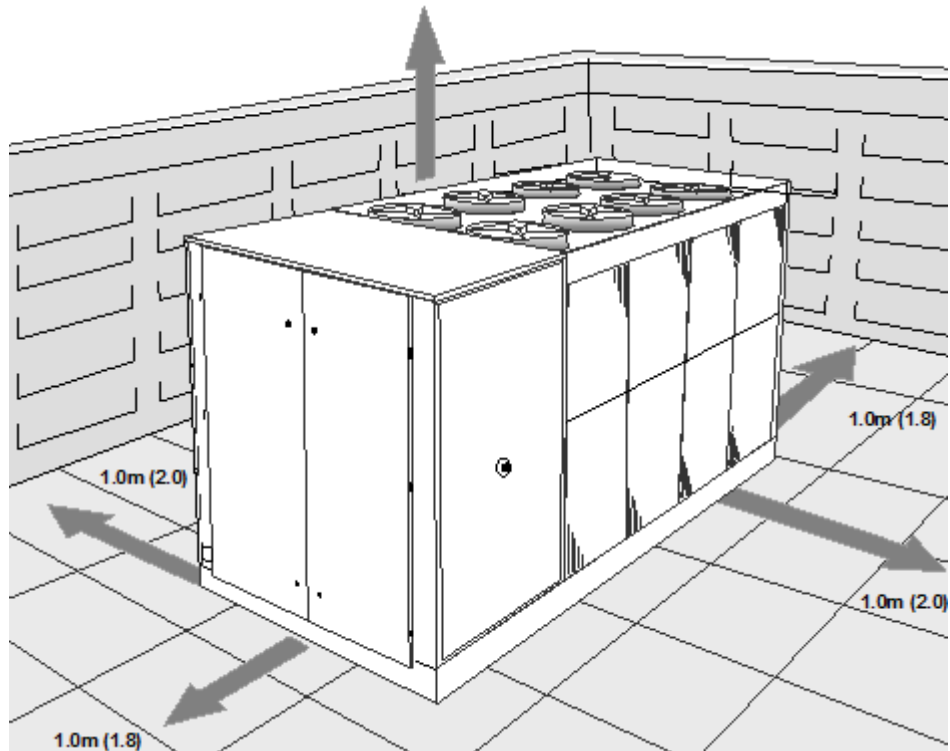

Installation Data

REFRIGERATION SYSTEM

Standard Recommended Installation

OUTDOOR UNIT - ULTIMA COMPACT CONDENSING UNIT

INDOOR UNIT - BY OTHERS

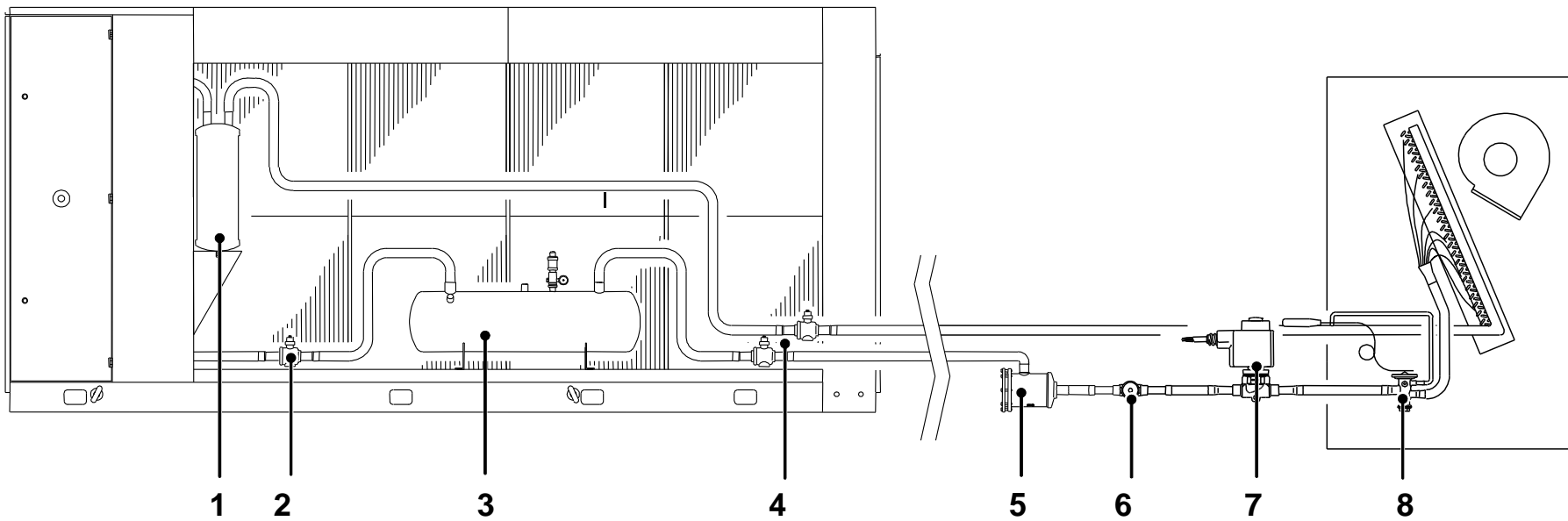

- 1 Suction accumulator (optional - factory fitted)
- 2 Receiver pump down ball valve (optional - factory fitted)
- 3 Liquid receiver & pressure relief assembly (optional - factory fitted)
- 4 Suction & liquid line ball valves (standard - factory fitted)
- 5 Filter drier (optional - supplied loose)
- 6 Sight glass (optional - supplied loose)
- 7 Solenoid valve (supplied by others)
- 8 Expansion valve (supplied by others)

Installation Data

REFRIGERATION CONNECTIONS

		UCCU30SQ-1/1	UCCU40SQ-1/1	UCCU50SQ-2/1	UCCU60SQ-2/1	UCCU70SQ-2/1	UCCU80SQ-2/1
Connections - Single Circuit	(1)						
Liquid Line	in	7/8	7/8	7/8	1 1/8	1 1/8	1 1/8
Suction Line	in	1 3/8	1 3/8	1 5/8	1 5/8	1 5/8	1 5/8
		UCCU30DQ-1/1	UCCU40DQ-1/1	UCCU50DQ-2/1	UCCU60DQ-2/1	UCCU70DQ-2/1	UCCU80DQ-2/1
Connections - Dual Circuit	(1)						
Liquid Line	in	3/4	3/4	3/4	7/8 / 3/4	7/8	7/8
Suction Line	in	1 1/8	1 1/8	1 1/8	1 3/8 / 1 1/8	1 3/8	1 3/8
		UCCU75D-2/1	UCCU100D-2/1	UCCU110D-4/2	UCCU125D-3/1	UCCU130D-4/2	UCCU150D-3/1
Connections	(1)						
Liquid Line	in	1 1/8	1 1/8	1 1/8	1 1/8	1 1/8	1 1/8
Suction Line	in	1 3/8	1 3/8	1 5/8	1 5/8	1 5/8	1 5/8
		UCCU160D-4/2	UCCU180D-6/2	UCCU200D-6/2	UCCU225D-6/2	UCCU240D-8/2	UCCU250D-6/2
Connections	(1)						
Liquid Line	in	1 1/8	1 1/8	1 3/8	1 3/8	1 5/8	1 3/8
Suction Line	in	2 1/8	2 1/8	2 1/8	2 1/8	2 5/8	2 1/8
		UCCU270D-8/2	UCCU300D-8/2	UCCU330D-10/2	UCCU360D-10/2	UCCU400D-12/2	UCCU450D-12/2
Connections	(1)						
Liquid Line	in	1 5/8	1 5/8	1 5/8 / 2 1/8	2 1/8	2 1/8	2 1/8
Suction Line	in	2 5/8	2 5/8	2 5/8	2 5/8	2 5/8 / 3 1/8	3 1/8

(1) Suitable For Brazed Connections.

PIPE SIZING GUIDE

Pipework sizes and routes should be set in accordance with good refrigeration practice.

PIPEWORK INSTALLATION

The suction line should be insulated.

Liquid lines should be insulated in areas of high temperature or when exposed to direct sunlight.

Special consideration should be given to vertical pipe runs and heat pump installation.

Unit performance will reduce if there are vertical rises of above 5m. Please consult Airedale Service for risers above 10m.

When insulating refrigerant lines, cut approximately 30 - 50cm longer than the distance between the units to ensure the insulation goes right upto the unit. Leave connections uncovered for leak testing.

Remove burrs to the ends of the copper tube, holding the tube downward to avoid allowing dirt to contaminate the tube.

Where applicable insert flare nuts removed from the pipework terminations and make a flare at the end of the copper tube to conform with the following:

- Inside surface is glossy and smooth
- Tapered sides are of uniform length
- Refrigeration lubrication is applied to mating surfaces

The installation of a sight glass close to the indoor unit is recommended.

Where applicable braze incoming pipe to rotalock service valve.

Installation Data

PRESSURE TESTING

In accordance with PED 97/23/EC, a strength test should be carried out in order to ensure that all interconnecting joints, pipework and components are sufficiently strong to cater for maximum permissible operating pressures. Once installation is completed, the high side of the system should be strength tested with dry nitrogen to a recommended **minimum** pressure of 27 barg and the low side to 17 barg.

CAUTION  **Pressure testing can be dangerous if not properly conducted, personnel undertaking pressure testing MUST be technically competent and suitably qualified.**

When installation is complete, the system should be pressure tested.

Fill the system with dry nitrogen to a pressure of between 17 bar/250psig and 34bar/500 psig.

Record the pressure over a minimum of 60 minutes to detect major leaks (a 24 hour period should preferably be allowed).

If a reduction in pressure is detected, trace the leak and repair before conducting a further pressure test and charging.

EVACUATION

Evacuation for systems operating with R407C refrigerant to be carried out as follows (for alternative refrigerants please refer to Airedale).

Use a high vacuum pump and connect to the high and low pressure sides of the system via a gauge manifold fitted with compound gauges. A high vacuum gauge should be fitted to the system at the furthest point from the vacuum pump.

Triple evacuation should be used to ensure that all contaminants are removed.

Operate the vacuum pump until a pressure of 1.5 torr (200 Pa) absolute pressure is reached, then stop the vacuum pump to break the vacuum using oxygen free Nitrogen until the pressure rises above zero.

The above operation should be repeated a second time.

The system should then be evacuated a third time but this time to 0.5 torr absolute pressure.

Break with the correct refrigerant, until pressures equalise between the charging bottle and the system.

ELECTRICAL

General

- As standard the equipment is designed for 400V, 3 phase, 3 wire 50Hz and a separate permanent 230V, 1 phase, 50Hz supply, to all relevant IEE regulations, British standards and IEC requirements.
- A fused and isolated electrical supply of the appropriate phase, frequency and voltage should be installed.
- The control voltage to the interlocks is 24V. Always size the low voltage interlock and protection cabling for a maximum voltage drop of 2V.

CAUTION  **Wires should be capable of carrying the maximum load current under non-fault conditions at the stipulated voltage.**

- Avoid large voltage drops on cable runs, particularly low voltage wiring.
- Once the connecting pipework is complete the electrical supply can be connected by routing the cable through the appropriate casing hole and connecting the cables, refer to the **Wiring Diagram** supplied with each unit.

CAUTION  **A separately fused, locally isolated, permanent single phase and neutral supply MUST BE FITTED for the compressor sump heater and control circuits, FAILURE to do so could INVALIDATE WARRANTY.**

Installation Data

INTERCONNECTING WIRING

Single Circuit

(not including: leak detector, and remote setpoint adjust)

UCCU30- UCCU80 (Excluding UCCU75)	L1	○	←	Mains incoming supply 400V/3PH/50Hz 50Hz (N2 Only Required For UCCU30-80Q/DQ & UCCU50-60SSQ/DSQ)
	L2	○	←	
	L3	○	←	
	N2	○	←	
	E	○	←	
	L4	○	←	Separate Permanent Supply 230V/1PH/50Hz
	N1	○	←	
	E	○	←	
	502	○	→	Circuit 1 24VAC (Suction Pressure Control Option), Compressor.1 24VAC (Digital I/P Control Option)
	504	○	←	
	502	○	→	Remote On/Off 24VAC, Compressor.2 24VAC (Digital I/P Control Option)
	505	○	←	
	500	○	→	0 v 0-10v Remote Capacity Control (0-10VDC Control Option)
	806	○	←	
	52	○	→	Circuit 1 Solenoid Valve Volt Free Contact N/O
	53	○	→	
	573	○	←	Circuit 1 Volt Free Common Alarm Volt Free Alarm N/O Volt Free Alarm N/C
	574	○	→	
575	○	→		
RX-/TX-	○	↔	Optional EEV Connections	
RX+/TX+	○	↔		
GND	○	↔		

Double Circuit

UCCU30 – UCCU450	L1	○	←	Mains incoming supply 400V/3PH/50Hz (N2 Only Required For UCCU30-80Q/DQ & UCCU50-60SSQ/DSQ)
	L2	○	←	
	L3	○	←	
	N2	○	←	
	E	○	←	
	L4	○	←	Separate Permanent Supply 230V/1PH/50Hz
	N1	○	←	
	E	○	←	
	502	○	→	Circuit 1 24VAC (Suction Pressure Control Option) / Compressor.1 24VAC (Digital I/P Control Option)
	504	○	←	
	502	○	→	Unit Remote On/Off 24VAC, Circuit 2 24VAC (Suction Pressure Control Option), Compressor.2 24VAC (Digital I/P Control Option)
	505	○	←	
	502	○	→	Compressor.3 24VAC (Digital I/P Control Option)
	506	○	←	
	502	○	→	Compressor.4 24VAC (Digital I/P Control Option)
	507	○	←	
	502	○	→	Compressor.5 24VAC (Digital I/P Control Option UCCU240-450 Only Excluding UCCU250)
	508	○	←	
502	○	→	Compressor.6 24VAC (Digital I/P Control Option UCCU240-450 Only Excluding UCCU250)	
509	○	←		
502	○	→	Remote On/Off 24VAC, Compressor.2 24VAC (Digital I/P Control Option)	
505	○	←		
500	○	→	0 v 0-10v Remote Capacity Control (0-10VDC Control Option)	
806	○	←		
52	○	→	Circuit 1 Solenoid Valve Volt Free Contact N/O	
53	○	→		
54	○	→	Circuit 2 Solenoid Valve Volt Free Contact N/O	
55	○	→		
573	○	←	Circuit 1 Volt Free Common Alarm Volt Free Alarm N/O Volt Free Alarm N/C	
574	○	→		
575	○	→		
576	○	←	Circuit 2 Volt Free Common Alarm Volt Free Alarm N/O Volt Free Alarm N/C	
577	○	→		
578	○	→		
RX-/TX-	○	↔	Optional EEV Connections	
RX+/TX+	○	↔		
GND	○	↔		

} Dual Circuit Only

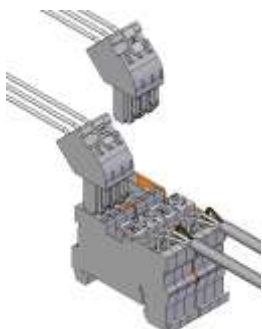

Installation Data

ELECTRICAL DATA		UCCU30SQ-1/1	UCCU40SQ-1/1	UCCU50SQ-2/1	UCCU60SQ-2/1	UCCU70SQ-2/1	UCCU80SQ-2/1
		UCCU30DQ-1/1	UCCU40DQ-1/1	UCCU50DQ-2/1	UCCU60DQ-2/1	UCCU70DQ-2/1	UCCU80DQ-2/1
Unit Data							
Nominal Run Amps	(1) A	27	28	38	43	47	58
Maximum Start Amps	(2) A	116	114	142	157	162	207
Permanent Supply	VAC			230 V 1 PH 50 Hz			
Mains Supply	VAC			400 V 3 PH 50 Hz			
Rec Permanent Fuse Size	A	16	16	16	16	16	16
Rec Mains Fuse Size	A	32	40	50	50	63	80
Max Permanent Incoming Cable Size	mm ²			4 mm ² terminals			
Max Mains Incoming Cable Size	mm ²			35 (Direct to Isolator)			
Control Circuit	VAC			24V/230VAC			
Condenser Fan - Per Fan							
Full Load Amps	A	3.00	3.00	3.00	3.00	3.00	3.00
Locked Rotor Amps	A	7.00	7.00	7.00	7.00	7.00	7.50
Motor Rating	Kw	1.75	1.75	1.75	1.75	1.75	1.75
Compressor - Per Compressor							
Quantity		2	2	2	2	2	2
Motor Rating	kW	4.7	6.2	8.1	9.5 / 8.1	9.5	11.7
Nominal Run Amps	(1) A	12.0	12.7	16.1	20.7 / 16.1	20.7	26.0
Crankcase Heater Rating	W	70.0	65.0	65.0	65.0 / 75.0	65.0	70.0
Start Amps	(2)	101.0	98.0	120.0	135.0 / 120.0	135.0	175.0
Type Of Start				Direct on line			
SUPER QUIET SQ		UCCU30SSQ-1/1	UCCU40SSQ-1/1	UCCU50SSQ-2/1	UCCU60SSQ-2/1	UCCU70SSQ-2/1	UCCU80SSQ-2/1
		UCCU30DSQ-1/1	UCCU40DSQ-1/1	UCCU50DSQ-2/1	UCCU60DSQ-2/1	UCCU70DSQ-2/1	UCCU80DSQ-2/1
		All data as above except:					
Condenser Fan - Per Fan							
Full Load Amps	A	1.15	1.15	3.50	3.50	1.15	1.15
Locked Rotor Amps	A	2.10	2.10	7.50	7.50	2.10	2.10
Motor Rating	kW	0.70	0.70	0.78	0.78	0.70	0.70
OPTIONAL EXTRAS							
Power Factor Correction							
Nominal Run Amps	(1) A	N/A	N/A	N/A	N/A	N/A	N/A
Maximum Start Amps	(2) A	N/A	N/A	N/A	N/A	N/A	N/A
Recommended Mains Fuse	A	N/A	N/A	N/A	N/A	N/A	N/A
Compressor Nominal Run Amps - Per Compressor	A	N/A	N/A	N/A	N/A	N/A	N/A
Electronic Soft-start							
Nominal Run Amps	(1) A	27	28	38	43	47	58
Maximum Start Amps	(2) A	76	77	94	103	108	137
Recommended Mains Fuse	A	32	40	50	50	63	80

- (1) Based at 7.2°C Evaporating and 54.4°C Condensing temperatures.
 (2) Starting amps refers to the direct on line connections.

Installation Data

ELECTRICAL DATA

		UCCU75D-2/1	UCCU100D-2/1	UCCU110D-4/2	UCCU125D-3/1	UCCU130D-4/2	UCCU150D-3/1
Unit Data							
Nominal Run Amps	(1) A	54	68	75	89	95	109
Maximum Start Amps	(2) A	140	172	179	238	244	258
Permanent Supply	VAC			230 V 1 PH 50 Hz			
Mains Supply	VAC			400 V 3 PH 50 Hz			
Rec Permanent Fuse Size	A	16	16	16	16	16	16
Rec Mains Fuse Size	A	63	80	100	125	125	125
Max Permanent Incoming Cable Size	mm ²			4 mm ² terminals			
Max Mains Incoming Cable Size	mm ²	70 (Direct to MCCB)	70 (Direct to MCCB)	Direct to Bus Bar	70 (Direct to MCCB)	Direct to Bus Bar	70 (Direct to MCCB)
Control Circuit	VAC			24V/230V AC			
Condenser Fan - Per Fan							
Full Load Amps	A	1.75	1.75	3.00	1.75	3.00	1.75
Locked Rotor Amps	A	6.20	6.20	7.00	6.20	7.00	6.20
Motor Rating	kW	0.98	0.98	1.75	0.98	1.75	0.98
Compressor - Per Compressor							
Quantity		4	4	4	2 + 2	2 + 2	4
Motor Rating	kW	6.2	8.1	8.1	8.1 / 11.7	8.1 / 11.7	11.7
Nominal Run Amps	(1) A	12.7	16.1	16.1	16.1 / 26.0	16.1 / 26.0	26.0
Crankcase Heater Rating	W	65.0	65.0	65.0	65.0 / 75.0	65.0 / 75.0	75.0
Start Amps	(2)	98.0	120.0	120.0	120.0 / 175.0	120.0 / 175.0	175.0
Type Of Start				Direct on line			
QUIET DQ		UCCU75DQ-2/1	UCCU100DQ-2/1	UCCU110DQ-4/2	UCCU125DQ-3/1	UCCU130DQ-4/2	UCCU150DQ-4/1
		All data as above except:					
Condenser Fan - Per Fan							
Full Load Amps	A	1.15	1.15	1.25	1.15	1.25	1.15
Locked Rotor Amps	A	2.10	2.10	4.50	2.10	4.50	2.10
Motor Rating	kW	0.68	0.68	0.69	0.68	0.69	0.68
SUPER QUIET DSQ		UCCU75DSQ-3/1	UCCU100DSQ-3/1	UCCU110DSQ-4/2	UCCU125DSQ-4/1	UCCU130DSQ-6/2	UCCU150DSQ-4/1
		All data as above except:					
Condenser Fan - Per Fan							
Full Load Amps	A	0.83	0.83	0.78	0.83	0.78	0.83
Locked Rotor Amps	A	1.50	1.50	1.50	1.50	1.50	1.50
Motor Rating	kW	0.32	0.32	0.48	0.32	0.48	0.32
OPTIONAL EXTRAS							
Power Factor Correction							
Nominal Run Amps	(1) A	49	61	68	80	86	97
Maximum Start Amps	(2) A	140	172	179	238	244	258
Recommended Mains Fuse	A	63	80	100	125	125	125
Compressor Nominal Run Amps - Per Compressor	A	4 x 11	4 x 13	4 x 13	2 x 20 / 2 x 13	2 x 20 / 2 x 13	4 x 20
Electronic Soft-start							
Nominal Run Amps	(1) A	54	68	75	89	95	109
Maximum Start Amps	(2) A	100	124	131	168	174	188
Recommended Mains Fuse	A	63	80	100	125	125	125

(1) Based at 7.2°C Evaporating and 54.4°C Condensing temperatures.

(2) Starting amps refers to the direct on line connections.

Installation Data

ELECTRICAL DATA

		UCCU160D-4/2	UCCU180D-6/2	UCCU200D-6/2	UCCU225D-6/2	UCCU240D-8/2	UCCU250D-6/2
Unit Data							
Nominal Run Amps	(1) A	115	132	146	158	170	172
Maximum Start Amps	(2) A	264	315	377	389	319	403
Permanent Supply	VAC			230 V 1 PH 50 Hz			
Mains Supply	VAC			400 V 3 PH 50 Hz			
Rec Permanent Fuse Size	A	16	16	16	16	16	16
Rec Mains Fuse Size	A	125	160	160	200	200	200
Max Permanent Incoming Cable Size	mm ²			4 mm ² terminals			
Max Mains Incoming Cable Size	mm ²			Direct to Bus Bar			
Control Circuit	VAC			24V/230V AC			
Condenser Fan - Per Fan							
Full Load Amps	A	3.00	3.00	3.00	3.00	3.00	3.00
Locked Rotor Amps	A	7.00	7.00	7.00	7.00	6.20	7.00
Motor Rating	kW	1.75	1.75	1.75	1.75	1.75	1.75
Compressor - Per Compressor							
Quantity		4	2 + 2	2 + 2	2 + 2	6	4
Motor Rating	kW	11.7	15.0 / 11.7	18.2 / 11.7	18.2 / 15.0	11.7	18.2
Nominal Run Amps	(1) A	26.0	32.0 / 26.0	39.0 / 26.0	39.0 / 32.0	26.0	39.0
Crankcase Heater Rating	W	75.0	130.0 / 75.0	130.0 / 75.0	130.0 / 130.0	75.0	130.0
Start Amps	(2)	175.0	215.0 / 175.0	270.0 / 175.0	270.0 / 215.0	175.0	270.0
Type Of Start				Direct on line			
QUIET DQ		UCCU160DQ-6/2	UCCU180DQ-6/2	UCCU200DQ-6/2	UCCU225DQ-8/2	UCCU240DQ-8/2	UCCU250DQ-8/2
		All data as above except:					
Condenser Fan - Per Fan							
Full Load Amps	A	1.25	1.25	1.25	1.25	1.15	1.25
Locked Rotor Amps	A	4.50	4.50	4.50	4.50	2.10	4.50
Motor Rating	kW	0.69	0.69	0.69	0.69	0.70	0.69
SUPER QUIET DSQ		UCCU160DSQ-6/2	UCCU180DSQ-6/2	UCCU200DSQ-8/2	UCCU225DSQ-8/2	UCCU240DSQ-10/2	UCCU250DSQ-8/2
		All data as above except:					
Condenser Fan - Per Fan							
Full Load Amps	A	0.78	0.78	0.78	0.78	0.83	0.78
Locked Rotor Amps	A	1.50	1.50	1.50	1.50	1.50	1.50
Motor Rating	kW	0.48	0.48	0.48	0.48	0.32	0.48
OPTIONAL EXTRAS							
Power Factor Correction							
Nominal Run Amps	(1) A	103	118	132	142	152	156
Maximum Start Amps	(2) A	264	315	377	389	319	403
Recommended Mains Fuse	A	125	125	160	160	160	200
Compressor Nominal Run Amps - Per Compressor	A	4 x 20	2 x 24 / 2 x 20	2 x 30 / 2 x 20	2 x 30 / 2 x 24	6 x 20	4 x 30
Electronic Soft-start							
Nominal Run Amps	(1) A	115	132	146	158	170	172
Maximum Start Amps	(2) A	194	229	269	281	249	295
Recommended Mains Fuse	A	125	160	160	200	200	200

(1) Based at 7.2°C Evaporating and 54.4°C Condensing temperatures.

(2) Starting amps refers to the direct on line connections.

Installation Data

ELECTRICAL DATA		UCCU270D-8/2	UCCU300D-8/2	UCCU330D-10/2	UCCU360D-10/2	UCCU400D-12/2	UCCU450D-12/2
Unit Data							
Nominal Run Amps	(1) A	188	206	231	252	279	303
Maximum Start Amps	(2) A	337	389	462	483	552	576
Permanent Supply	VAC			230 V 1 PH 50 Hz			
Mains Supply	VAC			400 V 3 PH 50 Hz			
Rec Permanent Fuse Size	A	16	16	16	16	16	16
Rec Mains Fuse Size	A	200	250	250	315	315	355
Max Permanent Incoming Cable Size	mm ²			4 mm ² terminals			
Max Mains Incoming Cable Size	mm ²			Direct to Bus Bar			
Control Circuit	VAC			24V/230V AC			
Condenser Fan - Per Fan							
Full Load Amps	A	1.75	1.75	1.75	1.75	1.75	1.75
Locked Rotor Amps	A	6.20	6.20	6.20	6.20	6.20	6.20
Motor Rating	kW	0.98	0.98	0.98	0.98	0.98	0.98
Compressor - Per Compressor							
Quantity		3 + 3	6	3 + 3	6	3 + 3	6
Motor Rating	kW	15.0 / 11.7	15.0	18.2 / 15.0	18.2	22.8 / 18.2	22.8
Nominal Run Amps	(1) A	32.0 / 26.0	32.0	39.0 / 32.0	39.0	47.0 / 39.0	47.0
Crankcase Heater Rating	W	130.0 / 75.0	130.0	130.0 / 130.0	130.0	130.0 / 130.0	130.0
Start Amps	(2)	215.0 / 175.0	215.0	270.0 / 215.0	270.0	320.0 / 270.0	320.0
Type Of Start		Direct on line					
QUIET DQ		UCCU270DQ-10/2	UCCU300DQ-10/2	UCCU330DQ-12/2	UCCU360DQ-12/2	UCCU400DQ-14/2	UCCU450DQ-14/2
All data as above except:							
Condenser Fan - Per Fan							
Full Load Amps	A	1.15	1.15	1.15	1.15	1.15	1.15
Locked Rotor Amps	A	2.10	2.10	2.10	2.10	2.10	2.10
Motor Rating	kW	0.70	0.70	0.70	0.70	0.70	0.70
SUPER QUIET DSQ		UCCU270DSQ-12/2	UCCU300DSQ-12/2	UCCU330DSQ-14/2	UCCU360DSQ-14/2	UCCU400DSQ-16/2	UCCU450DSQ-16/2
All data as above except:							
Condenser Fan - Per Fan							
Full Load Amps	A	0.83	0.83	0.83	0.83	0.83	0.83
Locked Rotor Amps	A	1.50	1.50	1.50	1.50	1.50	1.50
Motor Rating	kW	0.32	0.32	0.32	0.32	0.32	0.32
OPTIONAL EXTRAS							
Power Factor Correction							
Nominal Run Amps	(1) A	167	182	207	228	246	261
Maximum Start Amps	(2) A	337	389	362	483	552	576
Recommended Mains Fuse	A	200	200	250	250	250	315
Compressor Nominal Run Amps - Per Compressor	A	3 x 24 / 3 x 20	6 x 24	3 x 30 / 3 x 24	6 x 30	3 x 36 / 3 x 30	6 x 36
Electronic Soft-start							
Nominal Run Amps	(1) A	188	206	231	252	279	303
Maximum Start Amps	(2) A	267	303	354	375	424	448
Recommended Mains Fuse	A	200	250	250	315	315	355

(1) Based at 7.2°C Evaporating and 54.4°C Condensing temperatures.

(2) Starting amps refers to the direct on line connections.

AIRETronix - Controls

GENERAL DESCRIPTION

The microprocessor controller offers powerful analogue and digital control to meet a wide range of monitoring and control features including a real time clock and Industry standard communication port and network connections.

The controller's inbuilt display is used for viewing the unit operating status and making adjustments to control parameters by allowing the operator access to a series of display pages.

Also featured are a visual alarm and the facility to adjust and display control settings by local operator for information and control.

DISPLAY/KEYPAD

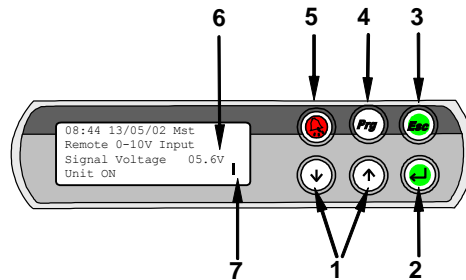

- 1 **UP/DOWN KEYS**
To change **Adjustable Fields & Scrolls** up & down available **Menus**
- 2 **ENTER**
Selects Menus & Moves Cursor to **Adjustable Fields** Green LED
- 3 **ESC**
Green LED lit when **Operating Page** displayed, Returns to **Operating Page** Screen when pressed
- 4 **PROGRAM**
Opens the Available **Menus**
- 5 **ALARM**
Red LED Indicates Alarm Present
- 6 **4 ROW LCD DISPLAY**
- 7 **CURSOR (FLASHING):** Top Left Position = "**HOME**" Indicates adjustable Fields

Navigation

The display is used for **Viewing Unit Operating Status** and **Adjusting Customer Control Settings** by allowing the operator access to a series of **Menus & sub-menus**. Viewing information is unrestricted, however set up and adjustment requires password entry, refer to **Password Protection**.

Initially, use the **Prg** key to **access Menus**, the symbol **←** will appear top right and the first menu will appear in CAPITALS, these **indicators** shows which menu is selected.

Use the **↓** **↑** keys to **move the indicator ←** to the desired menu and press **↵** to **open** the menu.

Use the **↵** key to **move the flashing cursor ||** to adjustable **fields** and the **↓** **↑** keys to change the values.

Press the **↵** key to **move the cursor** to the next **field** or **Home**.

When the cursor is **Home** either use the **↓** **↑** keys to scroll to next **sub-menu** or the **Esc** to **exit** and **return** to the **Standard Operating** page.

Standard Operating Page

The **Operating Page** will appear and remain present following start up of the controller as illustrated:

```

13:43 25/11/02  M1
Space Temp.   12.0°C
Supply Temp.  07.0°C
Unit ON:
    
```

} Indicates current Time, Date, Space and Supply air Temperatures and Unit On/Off

AIRETronix - Controls

OPERATION (CONT..)

Standard Operating Page cont.

The following **Menus** can be accessed from the **Operating Page**, it is recommended that the display is always returned to the **Operating Page** by using the  key

Password Protection

To guard against unauthorised adjustments, a password is required to gain access to certain menus as defined below.

FACTORY SET PASSWORD PIN NUMBER: 4648 (or Customer chosen number).

When a password is requested use the   keys to enter the number and  to access the page.

Menus (Listed in Sequence)

Menu	Description	Password
Switch On/Off	Enable or Disable the unit	Open Access
Service	Allows selection of setpoint limits, enables unit on/off from display, remote on/off and remote pump on/off.	Default 4648
Setpoint	Allows setpoint adjustment, includes supply temperature setpoint and unit temperature differential.	Default 4648
Status	Displays current status on digital and analogue inputs and outputs.	Open Access
Maintenance	Displays hours run for compressors and pumps (if fitted). Also includes Electronic Expansion Valves (if fitted).	Default 4648
Clock	Allows adjustment of real time clock, time zones	Default 4648
Alarm Log	Display last 100 alarms in chronological order.	Open Access
Manufacturer	Factory use only.	Airedale Only

VIEWING UNIT OPERATING STATUS

Status Menu

Allows access to view operating status of Digital and Analogue Inputs and Outputs.

Using the **Navigation** instructions and the wiring diagram provided, the relevant **Sub-Menus** can be accessed.

SETTING UP

Real Time Clock (Optional to UCC30-80 Single Circuit Only)

The units leave the factory set, however follow the **Navigation** instructions if necessary.

Time Zones

The programme provides 3 On/Off periods per day, 7 days per week. The unit is factory set for continuous operation.

Technical Support

For further details, please contact Airedale.







AIRETronix - Controls

ALARMS

The controller logs and allows viewing of the last 100 conditions recorded in descending chronological order.

13/05/02	11:32
Event number	001
Alarm Active	
37-Diff Pressr Evap	

Alarm Handling

- 1 A **Red LED** behind the **Alarm**  key will light in the event of an alarm. To view the alarms, simply press the  key and the   keys to scroll through.
- 2 Auto reset alarms will clear following this first depression of the **Alarm**  key. If however the **Red LED** behind the **Alarm**  key remains illuminated, the unit requires some form of manual reset.
- 3 For manual reset alarms, isolate the affected circuits before further investigation.
- 4 To reset or delete the alarms displayed in the alarm screen, simply press  again.

COMMON ALARMS

Outlined below is a selection of Common Alarms, a full list is available, please contact Airedale.

Phase Rotation (Optional)

A normally closed contact. When Phase Rotation is incorrect all controller outputs are de-activated.

Emergency Stop

A normally open contact. On closing, all controller outputs are de-activated.

INDIVIDUAL CIRCUIT ALARMS

Outlined below is a selection of Individual Circuit Alarms, a full list is available, please contact Airedale.

Low Suction Pressure

When the suction pressure sensor value falls below the value set by the low suction level for a period exceeding 1 minute (or 3 minutes on compressor start-up), a visual alarm will be generated at the in-built display and the relevant compressor will be de-activated. On units with tandem compressors, both compressors from the same circuit will be switched off.

High Liquid Pressure

When the liquid pressure reaches 25 BarG, the relevant circuit will be switched off and an alarm activated, this can only be rectified by manual reset via the microprocessor.

Compressor Status

A normally closed contact when the compressor is operating. If this contact remains open for a period of 3 seconds during operation of the compressor, a visual alarm is generated and the relevant compressor will be de-activated. This alarm comprises of compressor motor protection module, discharge gas thermostat and safety high pressure switch.

Commissioning Data

OPERATING LIMITS

Cooling	Standard Unit with Electronic Fan Speed Control (-20°C)
Minimum Ambient Air DB °C	-20°C
Maximum Ambient Air DB °C	Refer to Technical Manual - Performance Data - Capacity Data
Minimum Evaporating Temperature °C	-5°C
Maximum Evaporating Temperature °C	+10°C

1 For conditions outside those quoted, please refer to Airedale.

MECHANICAL DATA

Oil & Refrigerant Charges	UCCU30SQ-1/1 UCCU30DQ-1/1 UCCU30SSQ-1/1 UCCU30DSQ-1/1	UCCU40SQ-1/1 UCCU40DQ-1/1 UCCU40SSQ-1/1 UCCU40DSQ-1/1	UCCU50SQ-2/1 UCCU50DQ-2/1 UCCU50SSQ-2/1 UCCU50DSQ-2/1	UCCU60SQ-2/1 UCCU60DQ-2/1 UCCU60SSQ-2/1 UCCU60DSQ-2/1	UCCU70SQ-2/1 UCCU70DQ-2/1 UCCU70SSQ-2/1 UCCU70DSQ-2/1	UCCU80SQ-2/1 UCCU80DQ-2/1 UCCU80SSQ-2/1 UCCU80DSQ-2/1
Compressor	Single Circuit - Tandem Scroll / Double Circuit - 2 x Single Scroll					
Quantity	2	2	2	2	2	2
Oil Charge Volume (Total) l	1.5 + 1.5	1.6 + 1.6	1.9 + 1.9	3.0 + 1.9	3.0 + 3.0	3.6 + 3.6
Oil Type	Polyol Ester					
Refrigeration	Single Circuit / Double Circuit					
Holding Charge	Helium to 6.9 barg					
Refrigerant Type	R407C					
Charge (Total) (1) kg	5 + 5	6 + 6	6 + 6	8 + 8	8 + 8	10 + 10
	UCCU75D-2/1	UCCU100D-2/1	UCCU110D-4/2	UCCU125D-3/1	UCCU130D-4/2	UCCU150D-3/1
Compressor	Tandem Scroll - Hermetic					
Quantity	4	4	4	4	4	4
Oil Charge Volume (Total) l	4 x 3.25	4 x 3.80	4 x 3.80	2 x 6.20 + 2 x 3.80	2 x 6.20 + 2 x 3.80	4 x 6.20
Oil Type	Polyol Ester					
Refrigeration	Dual Circuit					
Holding Charge	Helium to 6.9 barg					
Refrigerant Type	R407C					
Charge (Total) (1) kg	20 + 20	22 + 22	22 + 22	25 + 25	22 + 22	30 + 30
QUIET DQ	UCCU75DQ-2/1	UCCU100DQ-2/1	UCCU110DQ-4/2	UCCU125DQ-3/1	UCCU130DQ-4/2	UCCU150DQ-4/1
Refrigerant Charge (Total) (1) kg	20 + 20	25 + 25	22 + 22	30 + 30	22 + 22	40 + 40
SUPER QUIET DSQ	UCCU75DSQ-3/1	UCCU100DSQ-3/1	UCCU110DSQ-4/2	UCCU125DSQ-4/1	UCCU130DSQ-6/2	UCCU150DSQ-4/1
Refrigerant Charge (Total) (1) kg	20 + 20	23 + 23	22 + 22	40 + 40	30 + 30	40 + 40
	UCCU160D-4/2	UCCU180D-6/2	UCCU200D-6/2	UCCU225D-6/2	UCCU240D-8/2	UCCU250D-6/2
Compressor - Scroll Hermetic	Tandem					
Quantity	4	4	4	4	6	4
Oil Charge Volume (Total) l	4 x 6.2	2 x 8.0 + 2 x 6.2	2 x 8.0 + 2 x 6.2	4 x 8.0	4 x 8.0	4 x 8.0
Oil Type	Polyol Ester					
Refrigeration	Dual Circuit					
Holding Charge	Helium to 6.9 barg					
Refrigerant Type	R407C					
Charge (Total) (1) kg	20 + 20	30 + 30	30 + 30	30 + 30	32 + 32	30 + 30
QUIET DQ	UCCU160DQ-6/2	UCCU180DQ-6/2	UCCU200DQ-6/2	UCCU225DQ-8/2	UCCU240DQ-8/2	UCCU250DQ-8/2
Refrigerant Charge (Total) (1) kg	30 + 30	30 + 30	30 + 30	40 + 40	32 + 32	40 + 40
SUPER QUIET DSQ	UCCU160DSQ-6/2	UCCU180DSQ-6/2	UCCU200DSQ-8/2	UCCU225DSQ-8/2	UCCU240DSQ-10/2	UCCU250DSQ-8/2
Refrigerant Charge (Total) (1) kg	30 + 30	30 + 30	30 + 30	40 + 40	38 + 38	40 + 40
	UCCU270D-8/2	UCCU300D-8/2	UCCU330D-10/2	UCCU360D-10/2	UCCU400D-12/2	UCCU450D-12/2
Compressor	Trio Scroll - Hermetic					
Quantity	6	6	6	6	6	6
Oil Charge Volume (Total) l	3 x 4.7 + 3 x 4.1	6 x 4.7	3 x 6.3 + 3 x 4.7	6 x 6.3	3 x 5.9 + 3 x 6.3	6 x 5.9
Oil Type	Polyol Ester					
Refrigeration	Dual Circuit					
Holding Charge	Helium to 6.9 barg					
Refrigerant Type	R407C					
Charge (Total) (1) kg	43 + 39	42 + 42	43 + 39	53 + 53	65 + 60	63 + 63
QUIET DQ	UCCU270DQ-10/2	UCCU300DQ-10/2	UCCU330DQ-12/2	UCCU360DQ-12/2	UCCU400DQ-14/2	UCCU450DQ-14/2
Refrigerant Charge (Total) (1) kg	43 + 39	40 + 40	54 + 49	49 + 49	65 + 60	72 + 72
SUPER QUIET DSQ	UCCU270DSQ-12/2	UCCU300DSQ-12/2	UCCU330DSQ-14/2	UCCU360DSQ-14/2	UCCU400DSQ-16/2	UCCU450DSQ-16/2
Refrigerant Charge (Total) (1) kg	52 + 48	46 + 46	56 + 51	70 + 70	82 + 76	80 + 80

(1) Unit supplied with a holding charge of Helium, the refrigerant charge is suitable for upto 10 metres of interconnecting pipework, additional refrigerant must be added for longer pipe runs.
All performance data is supplied in accordance with BS EN 14511-1:2013

Adding Refrigerant

Refrigerant should be added to the system via 1/4" schrader connection on the expansion line as required.

UNLOADING PROTECTION

Head Pressure

The microprocessor has inbuilt protection against nuisance trips. If the head pressure rises above 23 barg the system will unload 1 compressor and remain unloaded until the head pressure drops below 21 barg.

Low Pressure

If low pressure drops below the microprocessor setting, the compressor will unload to 1 compressor, if low pressure persists for 1 minute, the circuit will be switched off and sound an alarm.

Commissioning Procedure

GENERAL

To be read in conjunction with the commissioning sheets provided, items highlighted should be recorded.

CAUTION  Please ensure all documents have been completed correctly and return to Airedale Technical Support immediately to validate warranty.

PRE COMMISSIONING CHECKLIST

CAUTION  ALL work MUST be carried out by Technically Trained competent personnel.

The equipment contains live electrical and moving parts, ISOLATE prior to maintenance or repair work.

The door interlocking MCCB should be in the OFF position and the auxiliary alarm contact from the MCCB should be linked out.

All pipework is complete and insulated where necessary.

Check for the presence of a refrigerant charge in the condenser side.

IMPORTANT  Check phase rotation of electrical supply prior to running compressor as compressor is direction sensitive.

RECORD



The unit should be visually inspected and any damage noted.

- Secure commissioning gauges to the high side of the system, check for a positive charge.
- Check tightness of electrical components and properly terminated.
- Check external fuses/MCB are of correct rating.
- Check units properly earthed.
- Check pipework is earth bonded.
- Check that the remote on/off switch (if fitted) is in the off position.
- With the MCBs in the off position measure the incoming voltage.
- Check Phase Rotation.
- Check voltage and frequency at permanent supply.
- Measure and record the primary (230V) and secondary (24V) voltages at each of the transformers, adjust tapping if necessary and record on the commissioning document.
- Check all timer settings are correct.
- Check Sump Heater (**ensure this is switched on for a minimum of 2 hours prior to the unit operation**).
- Check oil level.
- Check fans rotate freely.
- Check system correctly evacuated.
- Check operating of HP/LP cut-out, settings LP cut-out - Auto/HP switch - manual:
High pressure switch - 26 bar (400 psi) - cut out
Low pressure cut-out - 0.5 bar (7 psi) - cut out
- Switch on the controls and individual circuits, primary and secondary, MCBs to the ON position. At this stage the control display panel should be illuminated.
- Record Optional Extras.
- Record Controller Data.





Commissioning Procedure

CAUTION  Disable remote ON/OFF to ensure the unit does not start unintentionally.

The unit will not start until microprocessor control SWITCH 1 is in the ON position. DO NOT SWITCH TO ON AT THIS STAGE

- Adjust the temperature supply and return set points (if necessary, via the chosen control management scheme) to call for 100% cooling (refer to the **Controls** section).
- Ensure all KNOBS and SWITCHES are adjusted to suit the design requirements (refer to the **Controls** section).





To switch the unit ON, use the microprocessor keypad as follows:

Press , press , press , press  & finally .

CAUTION  There will always be a delay between the enabling of the unit and the energising of the compressor contactors, anything between 1 to 2 minutes. Be patient.

- Check that each circuit trips on low pressure. The alarm should appear within 3 minutes.
- The alarm will be recognised at the display circuit trip, to clear the alarms refer to **Alarm Handling**.

To switch the unit OFF, use the microprocessor keypad as follows:

Press , press , press , press  & finally .

Fully open all liquid line and discharge service ball valves on each circuit.





Commissioning Procedure

COMMISSIONING CHECKLIST

The following should be carried out with a load on the system, otherwise the unit is likely to short cycle. The following tests are to be carried out on 1 circuit at a time.

- Switch the door interlocking MCCB to the ON position but again only on the circuit which is to be tested.
- Adjust the temperature supply and return set points to match the system requirements.

To switch the unit ON, use the microprocessor keypad as follows:

Press  , press  , press  , press  & finally  .





- Check pressures at suction and discharge ports for correct phase rotation.

CAUTION  **If no differential pressure occurs, isolate immediately.**

- RECORD** 
- Measure and record the compressor amps once the compressors are fully loaded and at the unloading stage.
 - Measure and record full speed amps of each condenser.

CAUTION  **The microprocessor LP setting is adjustable via the microprocessor keypad, factory set to 3.2BarG.**

- RECORD** 
- Check the liquid line sight glass is clear and dry.
 - Check the superheat setting adjusts the expansion valve to maintain a superheat setting of 5 – 8°C at all operating loads.
 - Check and record the following:
Suction and discharge pressures
Liquid, discharge and suction line temperature

- Ensure the above are all within the design parameters.
- Repeat as follows for each circuit:
- **To switch the unit OFF**, use the microprocessor keypad as follows:
Press  , press  , press  , press  & finally  .
- **To switch the unit ON**, repeat above.

The unit is now commissioned and will provide many years of trouble free operation providing the following maintenance schedule is followed.

Troubleshooting

FAULT	POSSIBLE CAUSE	REMEDY/ACTION
Unit Will Not Start	No power.	Check power supply to the controller.
	Wired incorrectly.	Check wire connections in accordance with wiring diagram on control box lid.
	Loose wires.	Check all wires, connections, terminals etc.
Compressor not operating	No power to compressor.	Check isolator, fuses, MCBs, contactor and control circuit wiring.
	Low pressure cut-out operated (large or complete loss of refrigerant charge).	Recover refrigerant, repair, evacuate and recharge system.
	Condenser fan thermal trip open circuit.	Investigate and correct.
	Seized compressor, possibly due to lack of oil.	Replace compressor - investigate oil trapping and general installation.
	Defective compressor motor.	Check winding resistances - replace compressor. If burnt out follow burn out procedure using suction line burn-out drier.
	Compressor thermal protection device operated.	Check if compressor overheated - possibly short of refrigerant
Noisy Compressor	Expansion valve malfunction (abnormally cold suction line).	Ensure feeler bulb is tight on suction and superheat is correct (normally 5 to 6°C). Replace power assembly or valve as necessary.
	Lack of oil.	Repair leaks if any, add oil if required but not too much - Remember too much is as bad as too little. Investigate pipe system and trapping. If no oil still, drain compressor and measure in correct quantity.
Head Pressure too high/HP cut-out operated	Condenser coil clogged or dirty.	Clean condenser.
	Overcharge of refrigerant. Normally troublesome in warm weather.	Remove excess refrigerant from system.
	Air or other non-condensable gas in system.	Evacuate system and re-charge with new refrigerant.
	Head pressure controller faulty.	Check fan speed controller - if faulty - replace.
	Fan not operating or operating inefficiently.	Check motor - if faulty - replace.
Head pressure too low	Fan operating too fast in low ambient conditions.	Check fan speed controller adjustment - if faulty - replace.

Troubleshooting

FAULT	POSSIBLE CAUSE	REMEDY / ACTION
Suction Pressure too low	Low evaporator airflow (not Airedale Unit).	Check fan motors, belts and drives.
	Flash gas (bubbles in sight glass) at expansion valve.	Investigate for refrigerant leaks, repair and re-charge system.
	Clogged filter drier (pressure / temperature drop across it).	Replace.
	Obstruction in liquid line solenoid valve.	Inspect, clean or replace.
	Obstruction in expansion valve.	Inspect, clean or replace.
Condenser fan not operating - power on	Power supply failure.	Check power supply at circuit breaker.
	Wiring to motors.	Check voltage at motor terminals.
	Motor / fan assembly jammed.	Isolate unit and check free rotation of motor/fan assembly. If faulty - replace.
	Motor internal overheat protector tripped.	Carry out continuity check at terminals "TK" in motor terminal box. If tripped and motor hot - check bearings. If tripped and motor cold - replace motor.
	Faulty motor windings/capacitor.	Motor humming would indicate fault in motor or capacitor. Check windings for continuity and if OK replace capacitor.
Condenser fan runs too fast	Minimum speed set too low.	Adjust head pressure controller to suit.
	High ambient condition or excessive recirculation of air around condenser coil.	Check installation against design.
	Minimum set speed setting incorrect.	Adjust as necessary.
	Incorrect pressure sensor setting.	Adjust via microprocessor.
	Faulty Fan Speed Controller.	Replace controller and sensor (as they are matched sets).
Condenser fans runs only slowly	Faulty pressure sensor.	Replace sensor.
	Incorrect pressure setting.	Adjust via microprocessor.
	Faulty Controller.	Replace controller and sensor (as they are matched sets).
	Faulty Pressure sensor.	Replace sensor.
	Motor/capacitor faulty.	Replace.
Condenser fans runs only slowly	Motor wired incorrectly.	Check against wiring diagram - correct as required.

Maintenance

CAUTION  **ALL work MUST be carried out by Technically Trained competent personnel.**

The equipment contains live electrical and moving parts, ISOLATE prior to maintenance or repair work.

GENERAL MAINTENANCE

The maintenance schedule indicates the time period between maintenance operations.

3 MONTHS	ACTION	NOTES
REFRIGERATION	Check the following and compare results with commissioning records. <ul style="list-style-type: none"> • Suction and discharge readings. • Head pressure control is maintained. • Pressure relief indicator gauge. • Check each circuit sight glass for dryness and bubbles for indication of leaks. • Check compressor oil level and shell/sump temperature. • Visually inspect the unit for oil patches. 	Investigate and rectify variations. Remember to re-cap the Schraeder connections!
		Investigate and repair possible leaks.
SYSTEM	Check the following against the commissioning records. <ul style="list-style-type: none"> • Control settings. • Alarm log for unusual occurrences. • Concurrently ensure chilled water pump and flow switch operate efficiently, and that interlocks function correctly. 	Investigate and adjust as necessary.
Finally!	Record operating conditions.	
FABRIC	Visually inspect the unit for general wear and tear, treat metalwork.	Rust should be inhibited, primed and touched up with matching paint (available from Airedale or your Distributor).
	Visually inspect pipe and pipework insulation.	Repair/rectify as necessary.
	Clean evaporator water strainer.	At first maintenance visit and then as frequently as necessary (12 months).
	Clean condenser coils. Do not steam clean use detergent and stiff bristled brush. For heavy dirt, use either a high pressure water or chemical hose.	Do not damage fins and comb out if necessary.
	Visually check the following: <ul style="list-style-type: none"> • Pipework clamps are secure. • Tightness and condition of fan and compressor mounts. • Anti-Vibration mounts fixings (if fitted). 	Secure/tighten as necessary.
Finally!	Ensure control panel lids and access panels have been correctly replaced and securely fastened in position.	

Maintenance

GENERAL MAINTENANCE (CONT.)

12 MONTHS	ACTION	NOTES
	Repeat 3 month checks plus the following:	
SYSTEM	Check safety devices cut out the compressor at the correct settings.	
REFRIGERATION	Leak test all R407C joints and inspect all water connections.	Rectify as necessary.
	Check superheats with system running on full load (the height of summer is recommended). Recheck the charge following major adjustment of the superheats.	Adjust as necessary. A period of 30 minutes should be allowed between each resetting of the valve to allow pressures to stabilise. Thermostatic expansion valve only.
ELECTRICAL	Tighten all electrical terminals.	

COMPRESSOR MAINTENANCE Periodic maintenance and inspection of this equipment is necessary to prevent premature failure, the following periodic inspections should be carried out by period or hourly use which ever is sooner.

1 Year	Measure compressor motor insulation.
7,500 Hours or 4 Years	Inspect compressor oil.

SHUT DOWN PERIODS For periods of winter shut down the following precautions are recommended:

- Close the liquid and discharge ball valve
- Cap service ports
- Turn off electrical circuits

Parts Identification

SPARES

For ease of identification when ordering spares or contacting Airedale about your unit, please quote the unit type, unit serial number and the date of manufacture, which can be found on the unit serial plate.

A spares list for 1, 3 and 5 years will be supplied with every unit and is also available from our Spares department on request.

- | | |
|-----------|--|
| 16 | Customer pipe connections Liquid |
| 17 | Customer pipe connections Suction |
| 18 | Mains Panel |
| 19 | Door Interlocking isolator |
| 20 | Emergency Stop |
| 21 | Condenser Coils |
| 22 | Incoming Customer Mains Access Points |
| 23 | Unit Controller Panel |
| 24 | Compressors MCBs |
| 25 | Modulating Head Pressure Controller |
| 26 | Fan Contactor MPCB |
| 27 | Compressor Contactors |
| 28 | Incoming Customer Mains 3 Phase |
| 29 | AireTronix Microprocessor Controller |
| 30 | Customer Permanent Supply/Controls Connections |

The serial plate can be located inside Item 18.

UCC .. /1 – DUAL CIRCUIT

- | | |
|-----------|---|
| 1 | Discharge Line Ball Valve (optional) |
| 2 | Discharge non return valve (optional) |
| 3 | Discharge Thermostat Switch |
| 4 | HP Switch |
| 5 | Suction Pressure Transducer |
| 6 | Compressor Electrical Terminal Box |
| 7 | Oil Level Sight Glass |
| 8 | Oil Sump Draw Point |
| 9 | Suction Port |
| 10 | Sump Heater |
| 11 | Compressor Feet/Resilient Mounts |
| 12 | Liquid Line |
| 13 | Suction Line |
| 14 | Compressor Compartment |
| 15 | Refrigeration Pipework & Optional Refrigeration components Compartment |

Parts Identification

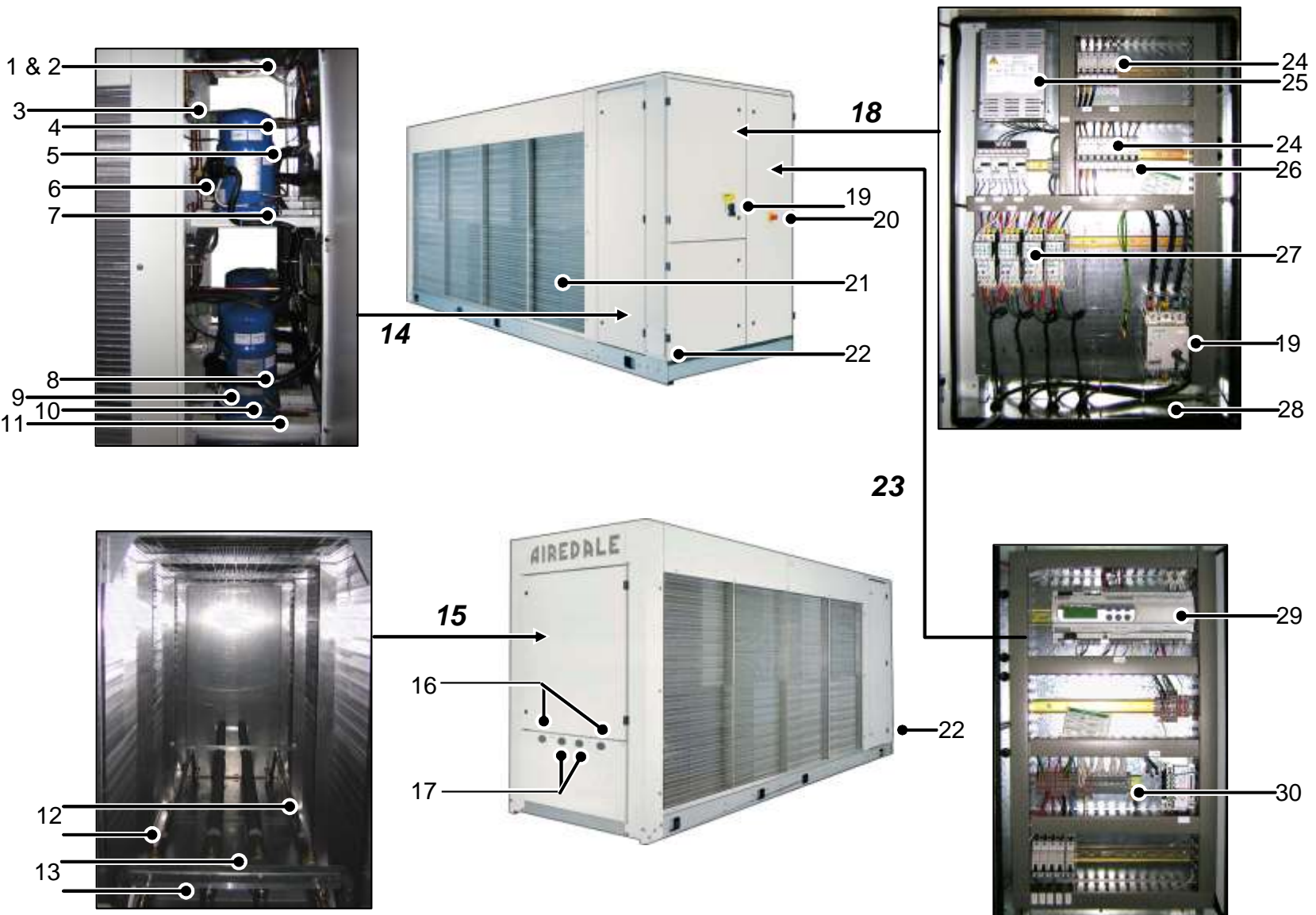

Notes:



Head Office:

Airedale International Air Conditioning Ltd
Leeds Road
Rawdon
Leeds LS19 6JY
United Kingdom

Tel: +44 (0) 113 239 1000

Fax: +44 (0) 113 250 7219

e-mail: enquiries@airedale.com

website: www.airedale.com



PART NO:	ISSUE	DATE
904-048 IM E	A	01/03/05
	B	06/06/05
	C	29/03/2010
	V1.3.0	18/02/13
	V1.4.0	10/2013
	V1.6.0	10/2014