



# INSTALLATION & MAINTENANCE MANUAL

## Ecotel Outdoor Upflow Telecom Unit TCU5 - TCU19D 5KW - 19KW



FM00542

EMS52086

**About Airedale Products & Customer Services**

**WARRANTY**

All AIAC products or parts (non consumable) supplied for installation within the UK mainland and commissioned by an AIAC engineer, carry a full Parts & Labour warranty for a period of 12 months from the date of commissioning or 18 months from the date of despatch, whichever is the sooner.

Parts or Equipment supplied by AIAC for installation within the UK or for Export that are properly commissioned in accordance with AIAC standards and specification, not commissioned by an AIAC engineer; carry a 12 month warranty on non consumable Parts only from the date of commissioning or 18 months from the date of despatch, whichever is the sooner.

Parts or equipment installed or commissioned not to acceptable AIAC standards or specification invalidate all warranty.

Warranty is only valid in the event that

In the period between delivery and commissioning the equipment: is properly protected & serviced as per the AIAC installation & maintenance manual provided where applicable the glycol content is maintained to the correct level.

In the event of a problem being reported and once warranty is confirmed as valid under the given installation and operating conditions, the Company will provide the appropriate warranty coverage (as detailed above) attributable to the rectification of any affected Airedale equipment supplied (excluding costs for any specialist access or lifting equipment that must be ordered by the customer).

Any spare part supplied by Airedale under warranty shall be warranted for the unexpired period of the warranty or 3 months from delivery, whichever period is the longer.

*To be read in conjunction with the Airedale Conditions of Sale - Warranty and Warranty Procedure, available upon request.*

**CAUTION** 

Warranty cover is not a substitute for maintenance. Warranty cover is conditional on maintenance being carried out in accordance with the recommendations provided during the warranty period. Failure to have the maintenance procedures carried out will invalidate the warranty and any liabilities by Airedale International Air Conditioning Ltd.

**SPARES**

A spares list for 1, 3 and 5 years will be supplied with every unit and is also available from our Spares department on request.

**TRAINING**

As well as our comprehensive range of products, Airedale offers a modular range of Refrigeration and Air Conditioning Training courses, for further information please contact Airedale.

**CUSTOMER SERVICES**

For further assistance, please e-mail: [enquiries@airedale.com](mailto:enquiries@airedale.com) or telephone:

<b>UK Sales Enquiries</b>	+ 44 (0) 113 238 7789	<a href="mailto:uk.sales@airedale.com">uk.sales@airedale.com</a>
<b>International Enquiries</b>	+ 44 (0) 113 239 1000	<a href="mailto:enquiries@airedale.com">enquiries@airedale.com</a>
<b>Spares Hot Line</b>	+ 44 (0) 113 238 7878	<a href="mailto:spares@airedale.com">spares@airedale.com</a>
<b>Airedale Service</b>	+ 44 (0) 113 239 1000	<a href="mailto:service@airedale.com">service@airedale.com</a>
<b>Technical Support</b>	+ 44 (0) 113 239 1000	<a href="mailto:tech.support@airedale.com">tech.support@airedale.com</a>
<b>Training Enquiries</b>	+ 44 (0) 113 239 1000	<a href="mailto:marketing@airedale.com">marketing@airedale.com</a>

For information, visit us at our Web Site: [www.airedale.com](http://www.airedale.com)

AIAC Ltd endeavours to ensure that the information in this document is correct and fairly stated, but none of the statements are to be relied upon as a statement or representation of fact. AIAC Ltd does not accept liability for any error or omission, or for any reliance placed on the information contained in this document.

The development of Airedale products and services is continuous and the information in this document may not be up to date. It is important to check the current position with AIAC Ltd at the address stated. This document is not part of a contract or licence unless expressly agreed.

No part of this document may be reproduced or transmitted in any form or by any means, electronic or mechanical, including photocopying, recording, or information storage and retrieval systems, for any purpose other than the purchaser's personal use, without the express written permission of AIAC Ltd.

© 2015 Airedale International Air Conditioning Limited. All rights reserved. Printed in the UK.

## Contents

GENERAL STATEMENT .....	3
WARRANTY .....	4
GENERAL DESCRIPTION.....	5
INSTALLATION DATA .....	6
GENERAL SPECIFICATION .....	9
OPERATING DATA .....	11
START UP DATA.....	13
CONTROLS.....	14
TROUBLESHOOTING .....	16
MAINTENANCE .....	19
PARTS IDENTIFICATION.....	21

## General Statement

### IMPORTANT

The information contained in this manual is critical to the correct operation and maintenance of the unit and should be read by all persons responsible for the installation, commissioning and maintenance of this Airedale unit.

### SAFETY

The equipment has been designed and manufactured to meet international safety standards but, like any mechanical/electrical equipment, care must be taken if you are to obtain the best results.

- CAUTION** ▼ 1 **Service and maintenance of Airedale equipment should only be carried out by Technically trained competent personnel.**
- CAUTION** ▼ 2 **When working with any air conditioning units ensure that the electrical isolator is switched off prior to servicing or repair work and that there is no power to any part of the equipment.**
- 3 Also ensure that there are no other power feeds to the unit such as fire alarm circuits, BMS circuits etc
- 4 Electrical installation commissioning and maintenance work on this equipment should be undertaken by competent and trained personnel in accordance with local relevant standards and codes of practice.
- 5 Refrigerant used in this range of products is classified under the COSHH regulations as an irritant, with set Workplace Exposure Levels (WEL) for consideration if this plant is installed in confined or poorly ventilated areas.
- 6 A full hazard data sheet in accordance with COSHH regulations is available should this be required.

## Warranty

### GENERAL

To be read in conjunction with Airedale International Air Conditioning Ltd standard Conditions of Sale.

All AIAC products or parts (non consumable) supplied for installation within the UK mainland and commissioned by an AIAC engineer, carry a full Parts & Labour warranty for a period of 12 months from the date of commissioning or 18 months from the date of despatch, whichever is the sooner.

### WARRANTY IS ONLY VALID IN THE EVENT THAT:

- 1 The equipment is serviced & maintained by Airedale or an approved Airedale company in accordance with the Installation & Maintenance manual provided, during the Warranty Period.
- 2 Commissioning is carried out by Airedale or an approved Airedale company.
- 3 Commissioning documents have been completed and returned to Airedale within 28 days of the date of commissioning.
- 4 Replaced faulty parts have been returned to Airedale within 21 days of replacement for evaluation.

Any spare part supplied by Airedale under the warranty shall be warranted for the unexpired period of the warranty or 3 months from delivery whichever period is the longer, with the exception of compressors on which a further 12 months warranty is granted.

### PROCEDURE

When a component part fails, a replacement part should be obtained through our Spares department. If the part is considered to be under warranty, the following details are required to process this requirement.

- Full description of part required, including Airedale's part number, if known.
- The original equipment serial number.
- An appropriate purchase order number.

<b>Faulty Component Return Tag</b>		No	28401
CUSTOMER _____		DATE _____	
ADDRESS _____			
AIREDALE U/No _____	CUST. O/No _____	Ex G/S No _____	
TYPE OF UNIT _____			
COMPONENT DESCRIPTION _____			
SERIAL No (where applicable) _____			
FAULTY DESCRIPTION ('Faulty' or 'Defective' not sufficient) _____			
DATE OF INVOICE _____		1. Original Equipment _____	
DATE OF INSTALLATION _____		2. Component (if different) _____	
DATE OF FAILURE _____			
<small>Airedale International Air Conditioning Limited                      Leeds Road, Rawdon, Leeds LS19 6JY                      Tel: 0113 239 1000 Fax: 0113 250 7219                      700-006</small>			<b>CUSTOMER COPY</b>

A spares order will be raised under our "G" number system and the replacement part will be despatched, usually within 24 hours should they be in stock.

When replaced, the faulty part must be returned to Airedale with a suitably completed and securely attached "Faulty Component Return" (FCR) tag. FCR tags are available from Airedale and supplied with each "G" order.

On receipt of the faulty part, suitably tagged, Airedale will pass to its Warranty department, where it will be fully inspected and tested in order to identify the reason for failure, identifying at the same time whether warranty is justified or not.

On completion of the investigation of the returned part, a full "Report on Goods Returned" will be issued. On occasion the release of this complete report may be delayed as component manufacturer becomes involved in the investigation.

When warranty is allowed, a credit against the "G" number invoice will be raised. Should warranty be refused the "G" number invoice becomes payable on normal terms.

### EXCLUSIONS

Warranty may be refused for the following reasons:

- Misapplication of product or component
- Incorrect site installation
- Incomplete commissioning documentation
- Inadequate site installation
- Inadequate site maintenance
- Damage caused by mishandling
- Replaced part being returned damaged without explanation
- Unnecessary delays incurred in return of defective component

### RETURNS ANALYSIS

All faulty components returned under warranty are analysed on a monthly basis as a means of verifying component and product reliability as well as supplier performance. It is important that all component failures are reported correctly.

## General Description

### UNIT IDENTIFICATION

ECOTEL OUTDOOR UNIT	
<b>TCU</b>	Telecom Communication Unit
<b>5 - 19</b>	Model Sizes (Nominal kW)
<b>D</b>	Dual Circuit
<b>XQ</b>	Extra Quiet Unit
<b>Example</b>	<b>Model TCU15D</b>

### INTRODUCTION

This self-contained packaged air conditioning unit is purpose built for Outdoor Telecom applications, including cabins, shelters and base stations and is available in 6 model capacity sizes and suitable for single or 3 phase electrical supplies.

The unit is externally mounted and utilises single or dual circuit refrigeration systems to provide 1, 2 or 3 stages of cooling. Single circuit units comprise of 5kW, 8kW, 11kW and 15kW. Double circuit units include 15kW and 19kW. All models have 1 free cooling stage. Units are configured for upflow applications. As standard the unit controller offers an additional energy saving feature by shutting off the evaporator fans at low room temperatures.

Each unit is pre charged with R407C, factory piped, wired to current EU standards, performance, leak and function tested prior to despatch.

The unit is despatched having been pre-commissioned ready for offering up to the appropriate services.

### CE DIRECTIVE



Airedale certify that the equipment detailed in this manual conforms with the following EC Directives:

Electromagnetic Compatibility Directive (EMC)	<b>2004/108/EC</b>
Low Voltage Directive (LVD)	<b>2006/95/EC</b>
Machinery Directive (MD)	<b>89/392/EEC in the version 2006/42/EC</b>
Pressure Equipment Directive (PED)	<b>97/23/EC</b>
Article 13	<b>2014/68/EU</b>

To comply with these directives appropriate national & harmonised standards have been applied. These are listed on the Declaration of Conformity, supplied with each product.

### STANDARD FEATURES

The unit features as standard:

- **AIRE**Tronix Microprocessor control
- Hermetic scroll compressor(s)
- Externally equalised thermostatic expansion valve(s)
- High pressure switch - automatic
- Low pressure switch - automatic
- Non Vision Grilles
- Operating charge
- Filter drier
- Sight glass
- Outside air damper
- Indoor Air Pressure relief
- Tool for tamperproof fixings

### OPTIONAL EXTRAS - GENERAL

#### Loose Item

- Shut off Damper
- Double Deflection Discharge Air Grille
- Roof Flashing Strip
- User Display

#### Factory Fitted

- Epoxy Coated Coils
- Electric Heating - Incorporating safety Cut out switch
- High Efficiency Filters
- External Mounting Brackets
- 48Vdc Emergency Cooling System
- Electronic Soft Start
- Single Phase Unit (Except TCU15)
- Maintenance 13A Socket
- Head Pressure Control
- Control Panel Interlock Switch
- Phase Sequence Relay
- Remote On/Off
- Real Time Clock
- BMS Communication
- Run/Standby
- Master/Slave
- Attend Mode

## Installation Data

### DIMENSIONS (MM)

### WEIGHTS (KG)

		Operating
TCU5	kg	212
TCU8	kg	217
TCU11	kg	280
TCU15	kg	285
TCU15D	kg	296
TCU19D	kg	400

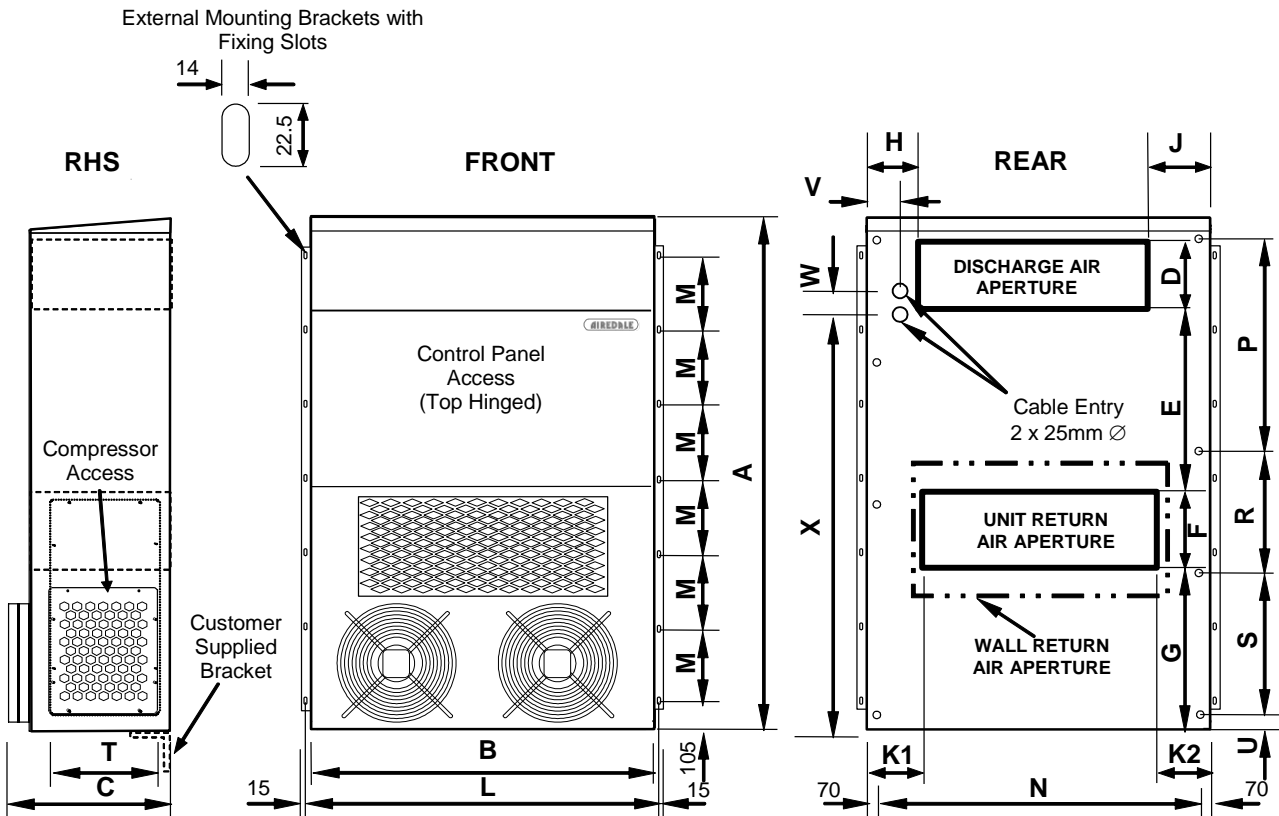

		A	B	C	D	E	F	G	H	J
TCU5	mm	1588	1005	650	200	552	250	535	177	228
TCU8	mm	1588	1005	650	200	552	250	535	177	228
TCU11	mm	2038	1365	600	263	768	325	633	296	269
TCU15 & TCU15D	mm	2038	1365	600	263	768	325	633	296	269
TCU19D	mm	2038	1365	661	263	768	325	633	296	269

		K1	K2	L	M	N	P	R	S	T	U
TCU5	mm	203	203	1030	675 x 2	866	N/A	N/A	N/A	320	N/A
TCU8	mm	203	203	1030	675 x 2	866	N/A	N/A	N/A	320	N/A
TCU11	mm	283	283	1395	300 x 6	1225	770	580	570	430	50
TCU15 & TCU15D	mm	283	283	1395	300 x 6	1225	770	580	570	430	50
TCU19D	mm	185	34	1395	300 x 6	1225	N/A	N/A	N/A	430	N/A

		Mains Incoming Hole Positions			Cabin/Wall Apertures*		Unit Apertures	
		V	W	X	Discharge	Return Air	Discharge	Return Air
TCU5	Mm	61	55	1354	600 x 200	600 x 410	600 x 200	600 x 250
TCU8	Mm	61	55	1354	600 x 200	600 x 410	600 x 200	600 x 250
TCU11	Mm	155	55	1883	800 x 263	800 x 480	800 x 263	800 x 325
TCU15 & TCU15D	Mm	155	55	1883	800 x 263	800 x 480	800 x 263	800 x 325
TCU19D	Mm	155	55	1883	800 x 263	1146 x 480	800 x 263	1146 x 325

1 The cabin/wall apertures are to be cut central to the unit apertures.

## Installation Data

### LIFTING/POSITIONING

- Remove packing and check that the unit is exactly as ordered. Any discrepancy to order, or transit damage, should be reported to Airedale immediately.
- Airedale recommends that whenever possible, the packaging is left covering the unit, to protect it from damage and general site debris.
- This small footprint unit is relatively tall and heavy. Care should be taken during handling and lifting, that the unit is well supported and properly balanced.
- Care should be taken that there are no obstructions to free airflow, particularly in the vicinity of the condenser fan discharge (outdoor) and also the return / discharge air (indoor).

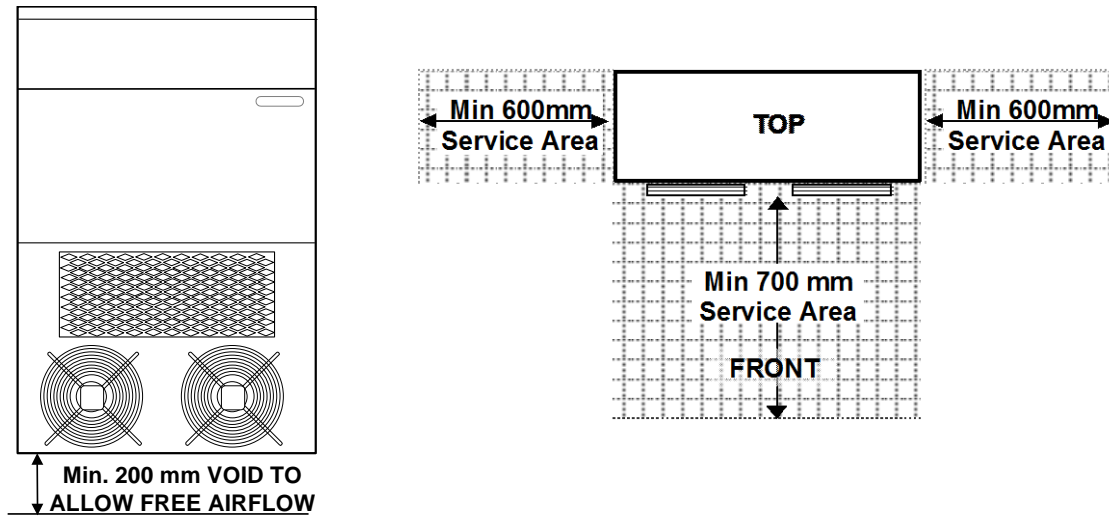

**CAUTION** ▼ Airedale will accept no responsibility for mishandling during the positioning of the equipment.

### DRAINAGE

Each module has condensate drain(s) exiting from the base of the unit which should be clear of obstructions.

The unit condensate drain trap(s) accessible through the unit side panel(s), require filling to be fully effective. Water should be added to the drain until water discharges from the condensate outlet.

## Installation Data

### INSTALLATION

**CAUTION**  **Units MUST be supported by a 3" cabin mounted angle iron (not supplied).**

- Check all services are present and accessible.
- Unpack the unit and remove securing straps, leaving unit on its pallet.
- Using appropriate lifting equipment, lift the unit on its pallet to the level of the angle iron/stand and ease into position (local codes and regulations should be observed).
- For external fixing: Once the unit is flush with the wall, secure the unit with 14 x M10 plated bolts, with a washer on the interior and exterior of the wall.
- For internal fixing: nutserts are provided in the rear of the AHU in order for M10 bolts of appropriate length to be passed through from the interior of the wall into the AHU, care should be taken not to damage the thread of the nutserts.
- Both the discharge and return air openings have a foam surround to provide a seal between the wall and the unit. A bead of sealant should be used to provide an air and water tight seal.\*
- Seal evenly around the seam between the unit and wall, achieving a water tight seal.\*
- The optional flashing strip should be fixed to the wall using screws (not provided). Seal to the wall and unit top using silicon sealant to prevent moisture ingress.\*
- Where a cavity wall exists between AHU and wall, a wall sleeve will be required. (Not supplied).
- Grille kits supplied are to be mounted into the cabin wall using self-tapping screw (Not supplied).
- Ensure there are no protrusions to the grille openings, which may foul the damper movement.

\*Airedale recommends the use of Dow Corning 794 or equivalent.

### ELECTRICAL

**CAUTION** 

- All mains and interconnecting wiring should be carried out to National and Local codes.
- A fused and isolated electrical supply of the appropriate phase, frequency and voltage should be installed.
- **Each unit requires an independently fused and isolated power supply.**
- Install mains supply refer to **Interconnecting Wiring** (optional 48Vdc. **NOTE:** – Connect the poles correctly), network connections and remote alarm interface cabling to unit by means of the supplied draw wire.
- Pass through the set holes the back of the evaporator section, feed through the top right hand side of the electrical control panel.
- Route via trunking and terminate in supplied terminals, refer to supplied wiring diagram.
- Check phase rotation before switching supply to the unit L1, L2, L3 (R, Y, B). Failure to do so will cause damage to the Scroll Compressor(s).
- If the installation has multiple units, check that unit identifications correspond with network diagrams supplied. Advise Airedale immediately of any discrepancies noted.



## General Specification

### ELECTRICAL DATA

TCU		5	8	11	15	15D	19D
<b>Electrical Supply Data</b>							
Nominal Run Amps	(1) A	4.6	6.8	8.5	11.4	10.9	18.7
Maximum Start Amps	(1) A	27.8	49.8	56.0	81.1	56.1	87.8
Recommended Mains Fuse	(1) A	10	16	16	20	16	25
Max Mains Incoming Cable Size	(1) mm <sup>2</sup>	1.50	1.50	1.50	2.50	1.50	4.0
Mains Supply		400V / 3PH + N / 50Hz					
Controls Circuit	Vac	24	24	24	24	24	24
<b>Evaporator Fan - per Fan (2)</b>							
Quantity		2	2	2	2	2	2
Motor Rating	W	120	120	210	210	210	415
Full Load Amps	A	0.54	0.54	0.97	0.97	0.97	2.00
Locked Rotor Amps	A	1.62	1.62	2.91	2.91	2.91	6.00
<b>Condenser Fan - per Fan (2)</b>							
Quantity		1	1	2	2	2	2
Motor Rating	W	292	292	204	245	245	610
Full Load Amps	A	1.1	1.1	0.91	1.1	1.1	2.8
Locked Rotor Amps	A	3.3	3.3	2.73	3.3	3.3	8.4
<b>Compressor 1 - per Compressor</b>							
Motor Rating	kW	1.6	2.9	3.4	4.9	1.6	2.4
Nominal Run Amps	A	2.9	5.2	6.2	8.7	2.9	4.54
Locked Rotor Amps	A	24.0	46.0	50.0	74.0	24.0	40.0
Type of Start		Direct on Line					
<b>Compressor 2 - per Compressor</b>							
Motor Rating	kW	N/A	N/A	N/A	N/A	2.9	4.2
Nominal Run Amps	A	N/A	N/A	N/A	N/A	5.2	8.0
Locked Rotor Amps	A	N/A	N/A	N/A	N/A	46.0	66.0
Type of Start		Direct on Line					
<b>OPTIONAL EXTRAS</b>							
<b>Heating</b>							
Unit Run Amps with Elec Htg	A	10.87	10.87	21.74	21.74	21.74	21.74
Electric Heater Rating	kW	2.5	2.5	5.0	5.0	5.0	5.0
Number of Stages		1	1	1	1	1	1
Number of Elements		1	1	2	2	2	2
<b>Electronic Compressor Soft Start</b>							
Reduced Start 3Ph Compressor 1	(3) A	14.2	28.3	30.6	45.8	14.2	24.0
Reduced Start 3Ph Compressor 2	(3) A	N/A	N/A	N/A	N/A	28.3	39.6
Reduced Start 1Ph Compressor 1	(3) A	25.9	55.0	62.2	N/A	25.9	N/A
Reduced Start 1Ph Compressor 2	(3) A	N/A	N/A	N/A	N/A	55.0	N/A
<b>Client's 48Vdc Emergency Power</b>							
Nominal Run Amps	A	5.90	5.90	5.90	16.30	16.30	20.2
<b>Single Phase Unit</b>							
Nominal Run Amps	(1) A	10.3	16.3	21.3	N/A	25.9	N/A
Maximum Start Amps	(1) A	51.9	104.9	120.9	N/A	112.3	N/A
Recommended Mains Fuse	(1) A	16	32	35	N/A	40.0	N/A
Max Mains Incoming Cable Size	(1) mm <sup>2</sup>	1.5	4.0	6.0	N/A	6.0	N/A
Mains Supply		230V/1PH+N/50Hz					
Controls Voltage	Vac	24	24	24	N/A	24	N/A
<b>Compressor 1 - per Compressor</b>							
Motor Rating	kW	1.6	2.9	3.5	N/A	1.6	N/A
Nominal Run Amps	A	7.6	13.6	17.1	N/A	7.6	N/A
Locked Rotor Amps	A	47.0	100.0	113.0	N/A	47.0	N/A
Type of Start		Direct on Line					
<b>Compressor 2 - per Compressor</b>							
Motor Rating	kW	N/A	N/A	N/A	N/A	2.9	N/A
Nominal Run Amps	A	N/A	N/A	N/A	N/A	13.6	N/A
Locked Rotor Amps	A	N/A	N/A	N/A	N/A	100.0	N/A
Type of Start		Direct on Line					

- (1) Cooling only unit (based at 35°C ambient and 50°C condensing temperature).
- (2) Includes pressure drops.
- (3) 3Ph Electronic Soft Start based on 40% Reduction In Compressor Starting Current.  
1Ph Electronic Soft Start based on 45% Reduction In Compressor Starting Current.

## Electrical Data

### INTERCONNECTING WIRING

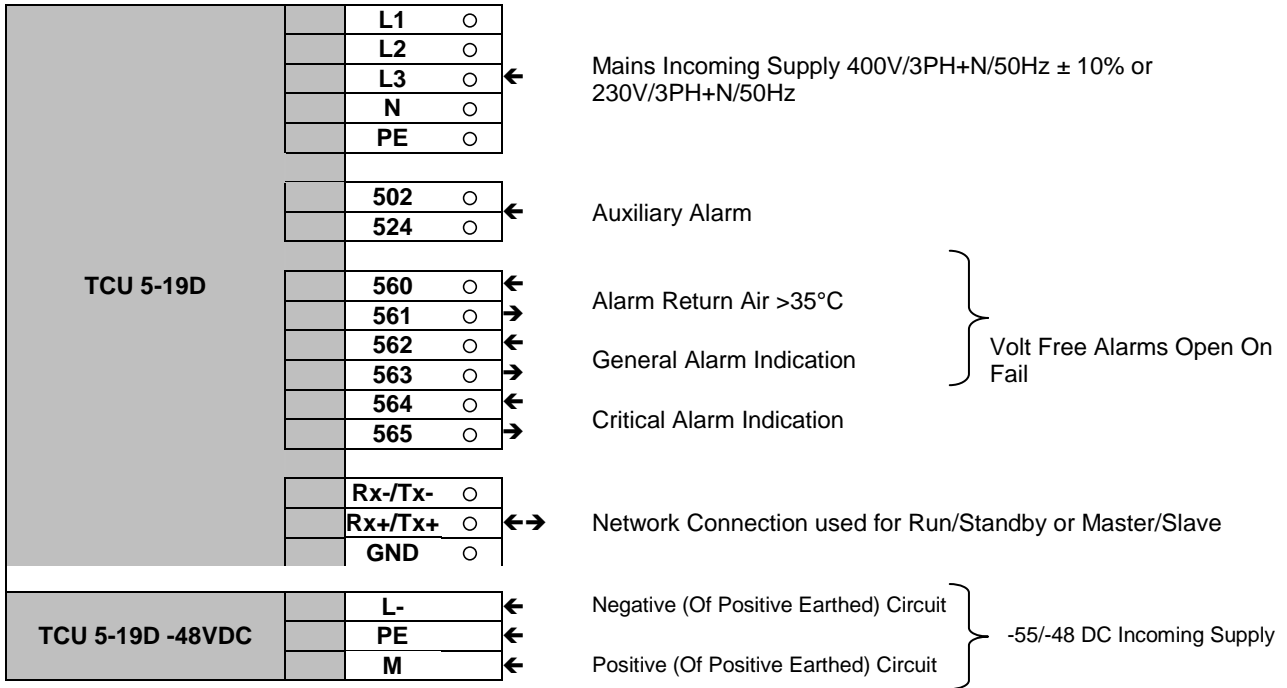

### ALARMS

Suggested hardwired alarm configurations

All Alarms in Series

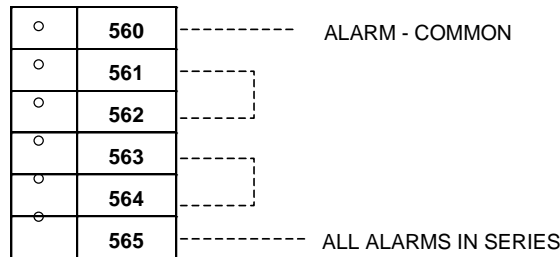

One Common for All Alarms

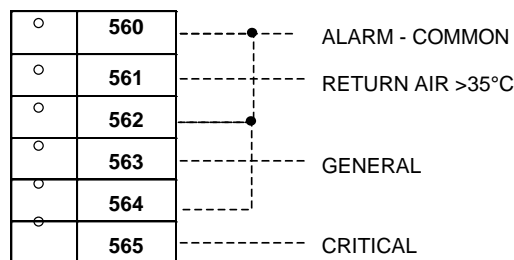

## Operating Data

### CONTROL - GENERAL

The **AIRE**Tronix microprocessor controller has been specifically designed to provide the control information necessary to operate the unit in an energy efficient manner.

An optional real time clock (RTC) offers energy savings and will time / date stamp alarms.

The unit will operate in 1 of 4 modes:

- 1 Free Cooling - using outside air only
- 2 Free Cooling and DX Cooling - using outside air and DX cooling
- 3 DX Cooling - mechanical cooling with room return air
- 4 Electric Heating (Optional Extra)

### FULL FREE COOLING

When the outside ambient temperature is low enough the fresh air damper will modulate between 0-100% using full fresh air to cool the room.

As a further consideration to energy efficiency, the condenser fan is off during full free cooling mode.

### FREE COOLING & DX COOLING

The controller will call for free cooling when the outdoor air temperature sensor senses the temperature of the outside air 2°C below the return air temperature. The **AIRE**Tronix microprocessor will then command the fresh air damper to open and modulate to satisfy the cooling load in the exchange. Until the external ambient drops low enough, the fresh air may not be capable of satisfying the cooling requirement of the room and DX cooling may also be required on an intermittent basis.

When the ambient is low enough and free cooling can totally satisfy the cooling requirement of the exchange, the damper will modulate to maintain the design room set point with just the supply fan operating. On low supply temperatures, the damper will modulate closed.

### MECHANICAL DX COOLING

When free cooling is unable to provide 100% cooling, the DX cooling system will maintain the temperature in the room.

### ELECTRIC HEATING (OPTIONAL EXTRA)

When heating is required, the unit will control as follows:

When the return air temperature drops below the room set point, the **AIRE**Tronix microprocessor will select the stage of electric heating to satisfy the heating requirement of the room. Once the room conditions have been satisfied, the electric heating will turn off to leave just the indoor fan re-circulating the room air.

### DAMPER POSITION

The minimum set point for the fresh air damper is fully adjustable via the optional display keypad.

In the event of a fire alarm signal (from the master BMS system), the damper will be driven shut and the unit will switch off.

### ALARMS

Return Air >35°C

General Alarm – Filter Change

Critical Alarm – Airflow failure, fan failure, HP or LP trip, Compressor failure etc.

## Operating Data

### UNIT OPERATION

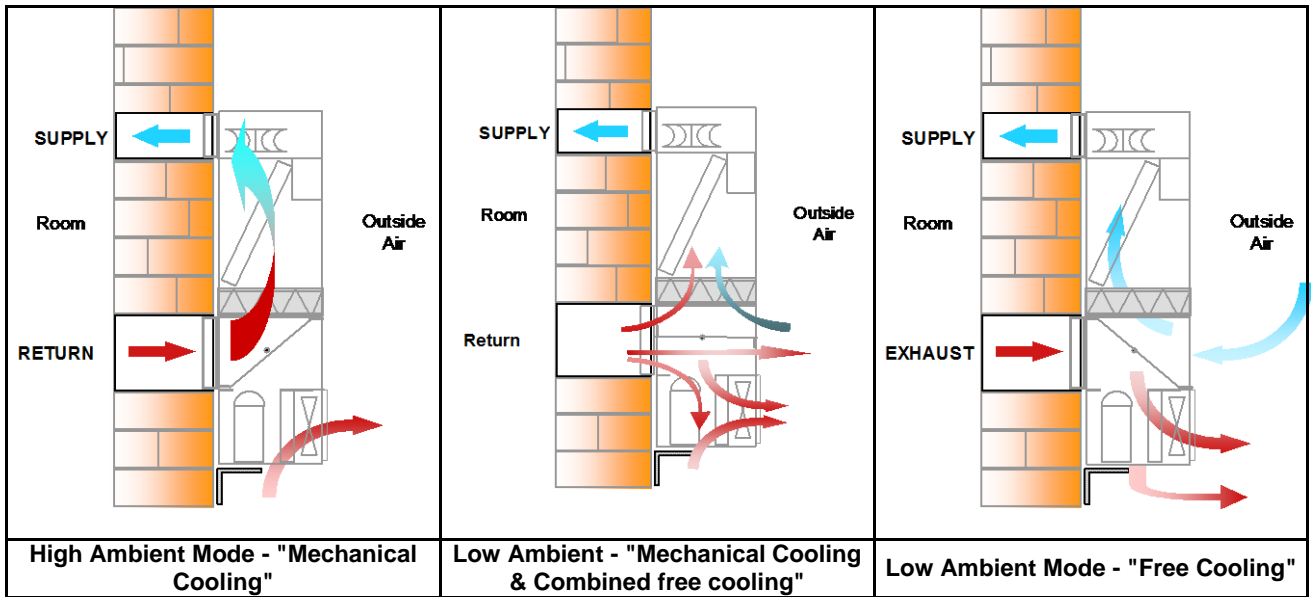

## Start Up Data

### GENERAL

Each Ecotel Outdoor unit leaves Airedale's manufacturing facility fully charged and pre-commissioned.

### PRE-START CHECKS

#### General

Once the whole system has been installed it is most important that the following pre-start checks are made:

- The equipment is exactly as ordered.
- All electrical terminals are tight.
- Power is available to the unit, via customers isolator and is at the correct voltage.
- Filters are of the correct grade and size.
- The thin pre-filter is under the main filter.
- Check that the condensate drain lines are precharged, not obstructed in any way and water flows away freely.

#### Electrical







Once the above installation and pre-start checks have been carried out satisfactorily, the main electrical checks can commence.

- Measure voltage (400 Vac 3 phase) L1 / L2, L2 / L3, L1 / L3.
- Measure voltage (230 Vac 1 phase) L1 & N (where applicable).
- Measure control transformer secondary voltage (24 Vac)
- **Note: - tolerance + / - 10%**
- Optional Extra - 48Vdc primary and secondary (24Vdc) voltages.
- **Note: - tolerance + / - 10%**
- Check phase rotation before switching supply to the unit. Failure to do so will cause damage to the Scroll Compressor(s).
- Check operation of auxiliary fire shutdown alarms on volt free contacts (if appropriate).
- **Note: - A test procedure and training is available on request.**

**AIRETronix - Controls**

**OPTIONAL KEYPAD OPERATION**





	<p><b>1 ALARM</b></p>	<p>When one or more alarm is active the ALARM button will illuminate red.</p> <p>Pressing the ALARM button once will indicate information regarding any active alarms.</p> <p>Pressing the ALARM button twice will reset any active alarms.</p>
	<p><b>2 PRG</b></p>	<p>Pressing the PRG button will select the main navigation menu.</p>
	<p><b>3 ESC</b></p>	<p>Pressing the ESC button will return the user to the main display screen showing unit status.</p>
	<p><b>4 UP</b></p>	<p>Pressing the UP button can either:</p> <ol style="list-style-type: none"> <li>1 Scroll through the various display screens, providing the cursor is in the top left position.</li> <li>2 Increase the value of a set point adjustment.</li> </ol>
	<p><b>5 ENTER</b></p>	<p>Pressing the ENTER button will confirm any set point adjustments and move the cursor to the next available set point.</p>
	<p><b>6 DOWN</b></p>	<p>Pressing the DOWN button can either:</p> <ol style="list-style-type: none"> <li>1 Scroll through the various display screens, providing the cursor is in the top left position.</li> <li>2 Decrease the value of a set point adjustment.</li> </ol>

## AIRETronix - Controls



### Navigation

The display is used for **Viewing Unit Operating Status** and **Adjusting Customer Control Settings** by allowing the operator access to a series of **Menus & sub-menus**. Each screen has a code in the top right hand corner for navigation and diagnostics reference. Viewing information is unrestricted, however set up and adjustment requires password entry, refer to **Password Protection**.

Initially, use the  button to **access the main navigation menu**, the **cursor** will appear in the top right hand corner with the first menu UNIT ON/OFF selected.

Use the  or  buttons to **move** to the desired menu. The selected menu will be shown in BLOCK CAPITALS.

Press  to enter the selected menu.

When the cursor is **Home** either use the  or  buttons to scroll to next **sub-menu** or the  to **exit** and **return** to the **Standard Operating** screen.

### Standard Operating Screen

The **Operating Screen** will appear and remain present following start up of the controller as illustrated:

```



12:06 09/11/11 M2
Room temp. : 24.5°C
OAT temp. : 12.0°C
OFF BY KEYBOARD Mst1
    
```

**CAUTION**  The date and time will only display correctly when the optional clock card is fitted.

### Password Protection

To guard against unauthorised adjustments, a password is required to gain access to certain menus as defined below.

**FACTORY SET PASSWORD PIN NUMBER: 4648 (or Customer chosen number).**

When a password PIN number is requested use the  and  buttons to enter the number and  to select and enter the number. This process will be repeated until all 4 digits of the PIN have been entered.

## Troubleshooting

FAULT	POSSIBLE CAUSE	REMEDY/ACTION
Unit not operating - Power Off.	Main/local isolator off	Check all isolators from mains to unit.
	Mains Fuse(s) failed.	Check all mains fuses. Replace after correcting fault. Check for loose wire.
Unit not operating - Power On.	Unit not switched on.	Check panel interlock switch is made (optional).
	Fault Alarm	Check volt free contacts, investigate and clear fault.
	Fire detection or external interlock fault no feed on wire.	Investigate and correct.
	Control MCB tripped.	<b>RE-SET AFTER INVESTIGATING AND CORRECTING FAULT.</b>
	Loose wire in control circuit	Investigate and tighten connector.
	Motor/Fan Assembly jammed.	Isolate unit and check free rotation of motor/fan assembly. If faulty - replace.
	Fan internal protection tripped.	Investigate internal protection, which is self-resetting. Check fan for correct operation. Replace if faulty.
	Faulty motor windings/capacitor.	Motor humming would indicate fault in motor or capacitor.
	Safety device or internal relay switch open circuit.	Check through circuitry starting at control MCB - action faults. Check primary and secondary voltage.
Anti cycling timer.	Wait until timer times out and try again. Limited to 10 starts/hour.	
Unit operating - No Cooling/Heating	Frost Protection DX Lockout	Unit in frost protection mode – No Action
	Overheat cut-out operation (optional)	If auto reset has tripped – heaters will reset automatically – Check fan and filters for sufficient airflow.  If manual reset has tripped – heaters can only be reset manually - Check fan and filters for sufficient airflow.
	Loose connection in control circuit.	Check and tighten connections.
High room temperature	Damper not operating correctly	Damper jammed in free cooling position during high ambient conditions.
	Compressor(s) not operating.	<b>REFER UNIT NOT OPERATING POWER OFF - POWER ON.</b>
	Compressor(s) not operating efficiently.	Important: Check electrical phase rotation. Fit gauges and investigate.
	Load too great for system.	High ambient affecting condenser performance. Investigate design and loads - clean coil fins.
Fan tripped.	Low airflow	Dirty filters - replace.
	Fan motor seized.	Free motor or replace.
	Fan jammed.	Remove obstruction.
	Control malfunction.	Check transformer/secondary supply - replace if faulty.  Re calibrate controls if necessary.  Check motor and wiring from controller. Check sensor not short-circuited - repair/replace.



## Troubleshooting

FAULT	POSSIBLE CAUSE	REMEDY/ACTION
Low Room Temperature.	Damper not operating correctly.	Damper jammed in full free cooling position during low ambient conditions.
	Compressor operating too long	Check sensors.
	Sensors incorrectly set or faulty.	Reset, repair or replace.
	Low airflow.	Dirty filters - replace.
	Heaters fail to operate	Check MCB/Contactor. Check wiring.
	Heater cut-out.	Check heater cut-out, reset if tripped.
Compressor not operating.	Control Malfunction.	Check transformer/secondary supply - replace if faulty.  Re calibrate controls if necessary.  Check fan motor and wiring from controller. Check detector not short-circuited - repair/replace.
	No power to compressor.	Check electrical connectors, isolator, MPCBs, contactor and control circuit wiring action. Always investigate fuse/contactor problem before replacements.
	Compressor discharge gas temperature protection device open.	Allow time to reset. Internal device, change compressor if it does not reset.
	Defective compressor motor.	Check windings resistance. If burnt out follow burn out procedure using drier in suction line. Always replace the contactor.
	Klixon tripped and does not reset.	Sometimes it takes up to 4 hours to reset. Replace compressor if necessary.
	Low pressure switch operated (large or complete loss of refrigerant charge).	Repair leak and recharge system. Evacuate before charging using good refrigeration practice.
Low evaporating temperature.	Low refrigerant charge.	Recharge refrigerant. (R407C)
	Expansion valve faulty or incorrectly set.	Replace or adjust expansion valve.
	Insufficient airflow through evaporator coil.	Check filter for clogging and fan speed.
Excessively high evaporating temperature.	Expansion valve faulty.	Replace valve.
Noisy compressor.	Start-up: Brief period of mechanical noise may be noticed on start up due to initial contacting of the spirals. This will quickly disappear.	No detrimental effect - no action necessary.
	Shut down: Compressor reverses momentarily as internal pressure equalises.	No detrimental effect - no action necessary.
	Check refrigeration charge.	If low, locate and repair leak and charge to correct design conditions adding Ester oil if necessary.
	Lack of oil.	Repair leaks if any, add oil if required but not too much - remember too much is as bad as too little.
	Expansion valve stuck in open position (abnormally cold suction line).	Ensure temperature bulb is tight on suction. Replace power assembly or valve if necessary.
	Broken or scored compressor bearings.	Replace compressor.
	Compressor (3 phase) rotation incorrect	Check electrical supply for correct phase rotation (R Y B)
Low superheat allowing liquid into compressor.	Check superheat.	

## Troubleshooting

FAULT	POSSIBLE CAUSE	REMEDY/ACTION
Loss of duty.	Low refrigerant charge.	Check for leaks, rectify and recharge.
	Expansion valve faulty.	Replace valve.
HP switch tripped.	Fan failed.	Replace faulty item.
	Condenser clogged or dirty.	Clean condenser. Refer to <b>Maintenance</b>
Head pressure too high.	Condenser clogged or dirty.	Clean condenser. Refer to <b>Maintenance</b>
	Re-circulating warm air.	Check for obstruction to external louvre.
Head pressure too low (often coupled with low pressure).	Fan operating too fast in low ambient conditions.	Check fan speed controller, adjust set points if necessary.
Compressor short cycles or LP cut-out operated.	Dirty air filters.	Clean or replace.
	LP switch operating too high.	Check operation, replace if necessary.
	Faulty TEV.	Replace expansion valve
	Lack of refrigerant (bubbles in sight glass only as indication).	Repair leak and recharge system.
	Low head pressure fan - over condensing in Winter.	Check fan speed controller, adjust set points if necessary.
Suction pressure too low.	Low evaporator airflow.	Check filters - clean or replace. Check inlet louvre for blockage.
	Flash gas (bubbles in sight glass) at expansion valve.	Investigate for leaks and top up system.
	Clogged Filter drier (pressure/temperature drop across it)	Replace
	Clogged or icing coil.	Defrost/clean, check filter.
	Faulty expansion valve.	<b>INSPECT, CLEAN OR REPLACE.</b>
	Erratic expansion valve (hunting).	Check bulb operation -replace.
	Head pressure control malfunction. Superheat too high.	Check - reset or replace. Check superheat.
Suction pressure too high.	Expansion valve passing too much.	Check bulb securely fastened, check superheat.
	Head pressure too high.	High ambient - check against design. Reduce head pressure. Check/repair controller.

## Maintenance

### GENERAL

Inspect last maintenance report and any intervening service reports. Pay particular attention to items mentioned.

### SAFETY

**WARNING : The equipment contains live electrical and moving parts, isolate all electrical equipment before any work is carried out.**

### ACCESS

Access to the compressor/condenser is achieved by removing the side panels. The control panel, evaporator coil and filter section are accessed by opening the hinged front door. Entry to the other side of the condenser coil and damper actuator is possible by removing the condenser fan panel and unplugging the condenser fan lead. (Please note a special tool is required to remove the securing bolts, Airedale part no. 515-596).

### SERVICE CHECKS - 3 MONTHLY

At every service visit the following checks should be carried out:

### FREE COOLING DAMPER

- 1 Clean surface of damper blade.
- 2 Check operation manually. This can be done by depressing the slide switch (to be found on the damper actuator body, housed in the condenser section). With the gears disengaged, check that the damper travels freely in both directions, to the limits of its travel.

### FAN & MOTOR ASSEMBLES

- 1 Examine the fan and motor assembly for lateral and end play in the bearings.
- 2 Check the electrical connections.
- 3 Examine the fan blades for damage and signs of wear.

### REFRIGERATION CIRCUITS

- 1 Check pipework and insulation including capillary lines. Tighten clamps if loosened.
- 2 inspect pipework for any damage and oil patches. If oil patches are found undertake leak check.
- 3 check the liquid line sight glass for a full liquid seal with compressor running. If bubbles are present undertake leak check.

**CAUTION**  If gauges are used do not forget to replace the security caps on the schraeder valves.

TCU	5	8	11	15	15D	19D
<b>Compressor</b>		Single Stage Fully Hermetic Compliant Scroll				
Quantity	1	1	1	1	2	2
Oil Charge Volume (Total)	1.0	1.1	1.8	1.85	1.00 & 1.10	1.00 & 1.95
Oil Type		Polyol Ester				
<b>Refrigeration</b>		Single Circuit			Dual Circuit	
Refrigeration Control		Thermostatic Expansion Device				
Refrigerant Type		R407C				
Charge (Total)	kg	1.8	2.0	2.3	3.98	2.0 & 3.0
					2.0 & 3.0	2.0 & 3.7

## Maintenance

### CONDENSER COIL

Clean the condenser coil with a stiff bristled hand brush.

If dirt has accumulated over a long period, or tends to be greasy or sticky, then it may be necessary to use a water hose (NOT High Pressure) or chemical pressure hose. Take care not to damage the fins and comb out if they have become damaged in any way.

**CAUTION**  **Do not use steam for cleaning coils otherwise damage or danger may result from excessive internal pressures.**

### EVAPORATOR COIL

- 1 Evaporator coil filters - check condition and replace if appropriate.
- 2 Inspect coils and clean as appropriate.

### ELECTRIC HEATING (OPTIONAL EXTRA)

- 1 Check electrical connections are secure.
- 2 Check operation of electrical heaters.
- 3 Check operation of manual reset overheat cut-out.
- 4 Check operation of automatic reset overheat cut-out.

**CAUTION**  **Manual switch cuts out at 120°C (±8.4°C).  
Automatic switch cuts out at 90°C (± 8.4°C) and resets at 60°C.**

### CABINET

Wash down cabinet using a mild detergent. Treat any paint damage or rust as necessary.

### ELECTRICAL

- 1 Check all electrical connections for signs of overheating or arcing.
- 2 Check all cables for signs of chafing or physical damage.

### CONTROLS

- 1 Visually inspect sensors and wiring.
- 2 Check operation and sequencing of controls via remote display.
- 3 Ensure that all relevant set-points are recorded.

### SERVICE CHECKS - YEARLY

- As 3 monthly plus the following:-
- 1 Check all electrical connections for tightness.
  - 2 Check all refrigeration connections with leak detector.

## Parts Identification

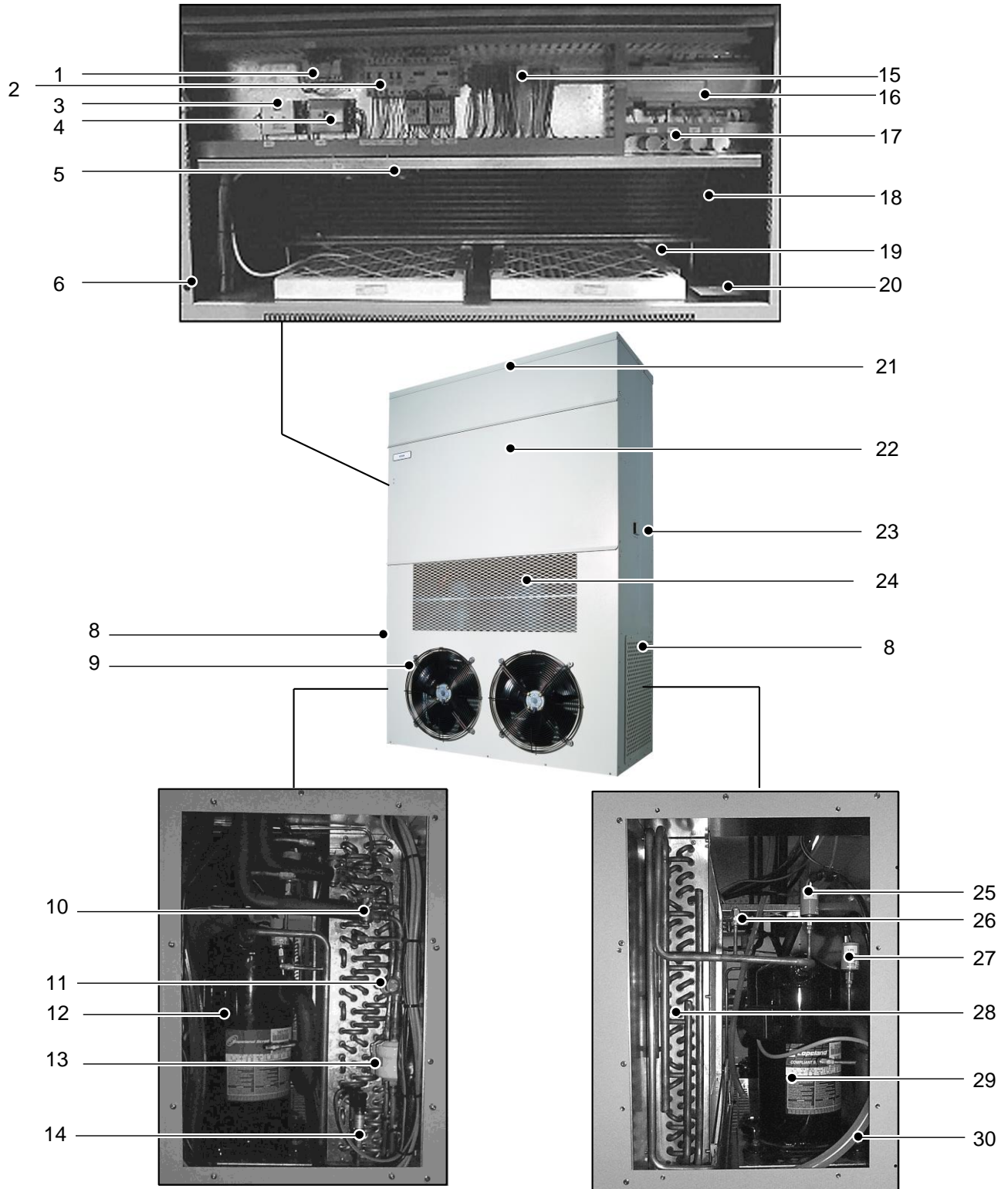

TCU15D Shown

## Parts Identification

- 1 Transformer 230/24 Vac
- 2 Miniature Circuit Breakers
- 3 Evaporator Fan Speed Controller
- 4 Condenser Fan Speed Controller (Optional)
- 5 Airflow Fail and Filter Dirty Flamtronic Switches
- 6 Panel Interlock Switch (optional)
- 8 Side Access / Maintenance Panels
- 9 Condenser Fans
- 10 Thermostatic Expansion Device
- 11 Sight Glass
- 12 First Stage Compressor
- 13 Filter Drier
- 14 Head Pressure Transducers
- 15 Incoming Customer Terminals
- 16 **AIRE**Tronix Microprocessor Controller
- 17 Fan Capacitors
- 18 Evaporator Coil
- 19 Pre and Main Filter
- 20 Serial Plate
- 21 Evaporator Fan Section
- 22 Front Hinged Access Panel
- 23 Ambient Sensor
- 24 Free Cool / Damper Section
- 25 High Pressure Switch
- 26 Schraeder Point
- 27 Low Pressure Switch
- 28 Condenser Coil
- 29 Second Stage Compressor (TCU15D & TCU19D)
- 30 Condensate Tube

## SPARES

For ease of identification when ordering spares or contacting Airedale about your unit, please quote the unit type, unit serial number and the date of manufacture, which can be found on the unit serial plate.

**The serial plate is located at point 20.**





**Head Office:**

**Airedale International Air Conditioning Ltd**  
Leeds Road  
Rawdon  
Leeds LS19 6JY  
United Kingdom

**Tel:** +44 (0) 113 239 1000  
**Fax:** +44 (0) 113 250 7219

**e-mail:** [enquiries@airedale.com](mailto:enquiries@airedale.com)  
**website:** [www.airedale.com](http://www.airedale.com)

A  **MODINE** Company

<b>PART NO:</b>	<b>ISSUE</b>	<b>DATE</b>
<b>901-061 IM E</b>	<b>A</b>	<del>01/06/04</del>
	<b>B</b>	<del>11/07/04</del>
	<b>C</b>	<del>23/11/04</del>
	<b>D</b>	<del>17/04/02</del>
	<b>E</b>	<del>18/06/03</del>
<b>6559595</b>	<b>F</b>	11/2011
	<b>G</b>	12/2012
	<b>V1.7.0</b>	02/2013
	<b>V1.8.0</b>	10/2014
	<b>V1.10.0</b>	11/2015